







Möwee es una actitud. Elegante. Sensual.  
Viva. Espacios outdoor donde sentirse  
como en casa.

Möwee is an attitude. Elegant. Sensual.  
Lively. Outdoor spaces where you can feel  
at home.



**Möwee forma parte del trabajo, esfuerzo y compromiso de Gaviota, empresa líder en el sector outdoor. Nace para ampliar horizontes en el mundo del mobiliario de exterior, de forma independiente. Con un carácter marcado por su forma de ser y de hacer. Frescura, sencillez, calidad y diseño son el corazón de su ADN.**

Möwee is part of the work, effort and commitment of Gaviota, a leading company in the outdoor sector. It was set up as an independent venture to broaden horizons in the outdoor furniture world, with its own distinctive character and way of doing things. Freshness, simplicity, quality and design are at the heart of its DNA.

# ESSENCE MÖWEE



**Sentimos la necesidad de hacer propio aquello que nos rodea. Objetos con significado, diseños con alma, piezas que reflejan nuestra personalidad, o que simplemente nos hacen sentir. Necesitamos hacer de cualquier espacio, nuestro oasis particular.**

**Möwee más que una marca, es una actitud. Elegante. Sensual. Viva. Su objetivo es crear espacios outdoor donde sentirse como en casa, aportando un toque original, fresco y con personalidad. En constante innovación, con la creatividad como estilo de vida. Cada colección, es una declaración de intenciones. Seducir a través de los sentidos y conquistar con los detalles. Diseño de vanguardia y fabricación propia, de principio a fin. El resultado es nuestra razón de ser, la esencia que nos hace únicos.**

We feel the need to make the things around us our own. Meaningful objects, designs with soul, pieces that reflect our personality or that simply resonate with us. We need to make any space into our own private oasis.

Möwee is more than a brand, it's an attitude. Elegant. Sensual. Alive. It's aim is to create outdoor spaces for feeling at home, giving them an original touch that's fresh and full of personality. In constant innovation, with creativity as a lifestyle. Each collection is a statement of intent. Seducing through the senses and winning hearts with details. Cutting edge design made in house from start to finish. The result is our reason for being, the essence that makes us unique.



# TECHNIC MÖWEE



**Möwee crea mobiliario para ser vivido. Atemporal, sostenible, funcional y de calidad. Sin perder la elegancia del diseño y arquitectura contemporánea. El mundo outdoor es exigente. Requiere la reinención de recursos para mantener el equilibrio entre tecnología, resistencia y confort. Pero sin duda, nuestro secreto es la innovación, compromiso y pasión común por el trabajo bien hecho.**

Möwee creates furniture to be lived. Timeless, sustainable, functional and quality. Without losing the elegance of design and contemporary architecture. The outdoor world is demanding. It requires the reinvention of resources to maintain the balance between technology, strength and comfort. But without a doubt, our secret is innovation, commitment and common passion for a job well done.



Somos sensibles al buen diseño, desde una gestión global y sostenible.

We are sensitive to good design, from a global and sustainable management.

**“No es sólo lo que hacemos, sino lo que somos y lo que construimos a nuestro alrededor. Evolucionar y mejorar. Minimizar el impacto en el medioambiente y cuidar nuestro entorno, depende de nosotros mismos. Cuidamos nuestras materias primas, métodos y procesos, porque nuestros productos y la naturaleza, son para toda la vida.”**

“It’s not just what we do, but what we are and what we build around us. Evolve and improve. Minimizing the impact on the environment and taking care of our environment depends on ourselves. We take care of our raw materials, methods and processes, because our products and nature, are for life.”





# DESIGN MÖWEE

Pura inquietud, peculiaridad y pasión.

Pure restlessness, curiosity and passion.



Héctor Serrano

**Pura inquietud, peculiaridad y pasión. Su vocación, el diseño industrial. Para él, la clave del éxito es el equilibrio entre tradición e innovación. Con sus diseños fieles a la sencillez y la belleza, ha conseguido ir un paso mas allá y recibir grandes premios como el Red Dot, Interior Design o el New Bus for London. Así como impulsar Borealis, una iniciativa propia dónde realiza el diseño de espacios e instalaciones efímeras.**

Pure curiosity, quirkiness and passion. A vocation for industrial design. The key to success is the balance between tradition and innovation. With designs loyal to simplicity and beauty, taking his practice to new levels and winning major awards such as Red Dot, Interior Design and New Bus for London. He also works on Borealis, his own initiative, in which he designs ephemeral spaces and installations.



Un ambigrama con carácter, frescura y singularidad.

An ambigram with character, freshness and uniqueness.



Yonoh Studio



**Un ambigrama con carácter, frescura y singularidad, que nace del afán de romper esquemas. Formado por Clara del Portillo y Alex Selma, especializados en producto e interiorismo. Amantes de los detalles, cuidan con mimo todos sus diseños, los cuales se caracterizan por su sencillez y funcionalidad. Gracias a su personalidad han sido reconocidos con premios tan prestigiosos como Red Dot o IF Design Award, entre otros.**

An ambigram with character, freshness and individuality, arising from the urge to break the mould. Produced by Clara del Portillo and Alex Selma, product and interior design specialists. With an eye for detail, they apply painstaking care to all their designs, characterised by their simplicity and functionality. Their personality has led them to winning some prestigious awards, including Red Dot or IF Design Award.

Equilibrio entre diseño e ingeniería de vanguardia.

Balance between design and state-of-the-art engineering.



Bandada Studio



**Bandada Studio es un talentoso equipo multidisciplinar que desarrolla los proyectos más sostenibles e innovadores . Está formado por un equipo de diseñadores e ingenieros, con más de 20 años de experiencia en el sector. Trabajamos para ofrecer calidad y confort en todos nuestros productos.**

Bandada Studio is a talented multidisciplinary team that develops the most sustainable and innovative projects. It is formed by a team of designers and engineers, with more than 20 years of experience in the sector. We work to offer quality and comfort in all our products.





RAL 9016







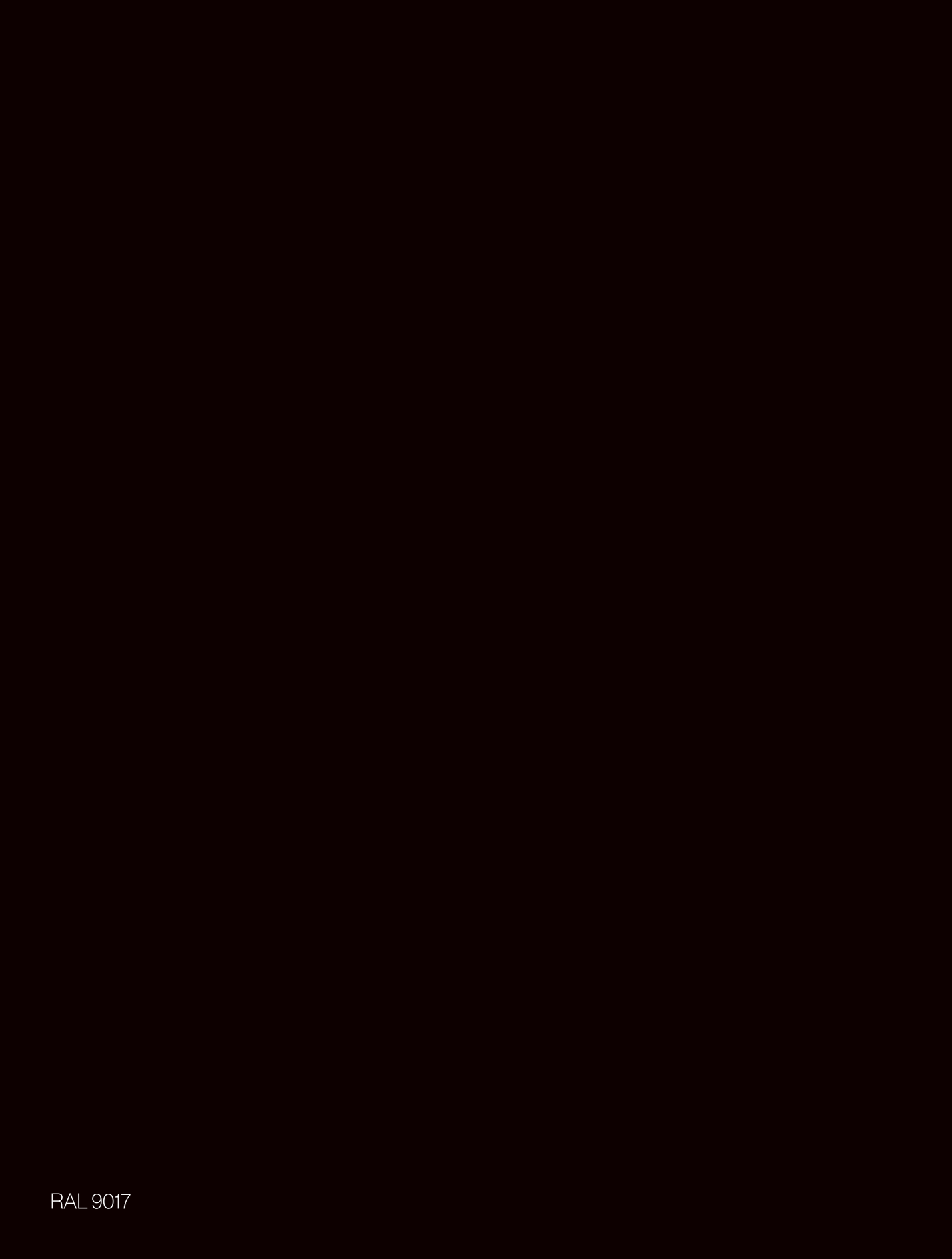









RAL 8017





RAL 7044







XALOC	34
CLASSE	56
LACE	70
UNI	96
RIBBONS	108
COVER	116
NATURE	126
BREZ	134
TECHNICALS	146

# XALOC

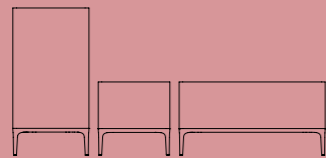
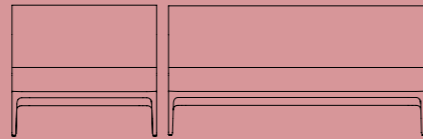
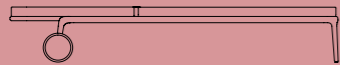
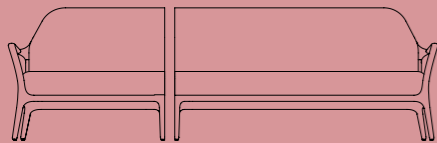
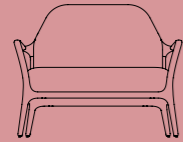

**Ese viento tan nuestro, del Mediterráneo. Armónico. Cambiante. Ubicuo. Fresco. Capaz de erosionar y esculpir suaves líneas, como la fundición del aluminio. Dócil. Orgánico. Moldeable. La variedad de tejidos, colores y piezas nos permite llevar la elegancia y calidez de los espacios interiores, al exterior.**

That Mediterranean wind, so uniquely ours. Harmonious. Changing. Pervasive. Fresh. Able to erode and sculpt smooth lines, like forging aluminium. Docile. Organic. Malleable. The variety of fabrics, colours and pieces allows us to take the elegance and warmth of indoor spaces outside.





Xaloc by Héctor Serrano





Xaloc by Héctor Serrano





Möwee Outdoor **Xaloc**



**Xaloc** by Héctor Serrano





Xaloc by Héctor Serrano





Möwee Outdoor **Xaloc**



Xaloc by Héctor Serrano





Möwee Outdoor **Xaloc**



**Xaloc** by Héctor Serrano





Xaloc by Héctor Serrano





Xaloc by Héctor Serrano





Möwee Outdoor **Xaloc**

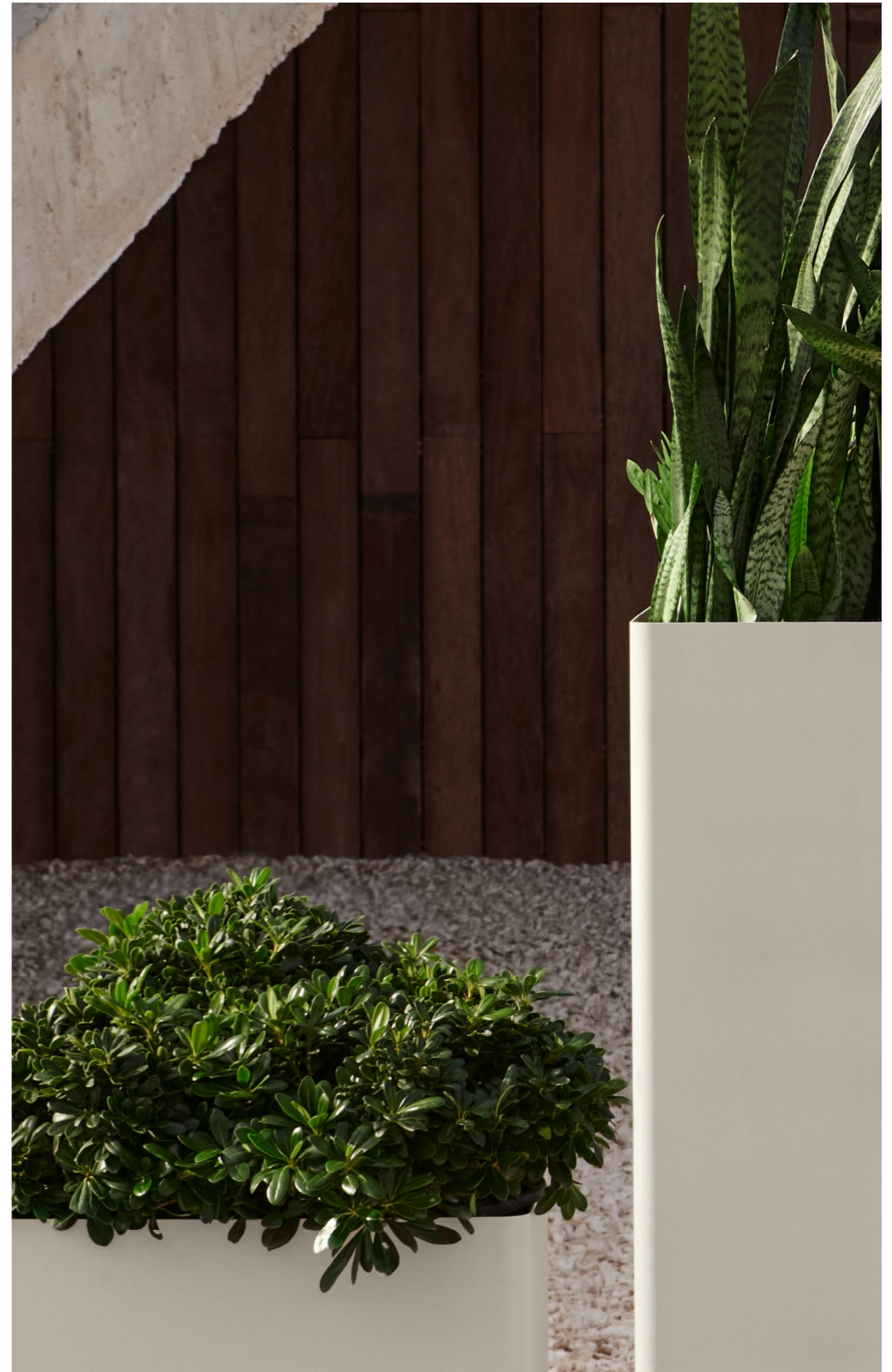

Xaloc by Héctor Serrano





Möwee Outdoor **Xaloc**



# CLASSE

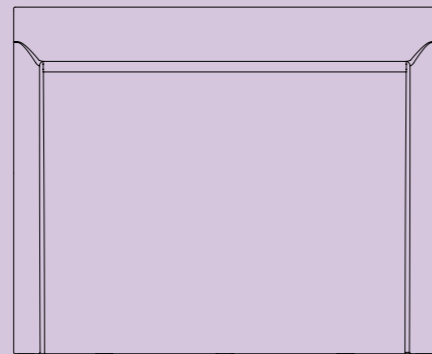
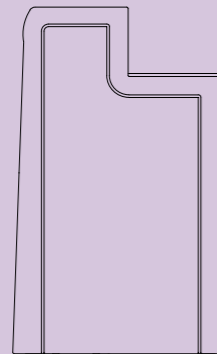
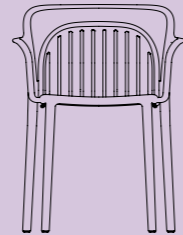
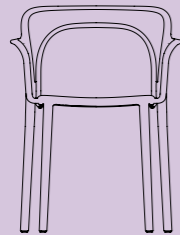
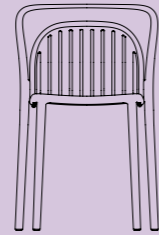
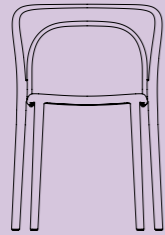

**Una combinación de estilos clásicos y contemporáneos. Sus curvas. Su estructura. Una colección singular, orgánica, ergonómica y con personalidad. Sillas de una sola pieza, apilables, realizadas en polipropileno, y barras de bar, realizadas en polietileno, todo ello diseñado para vivir al aire libre.**

A blend of classic and contemporary styles. Their curves. Their structure. A unique, organic, ergonomic collection with personality. Single piece stackable, made with polypropylene and polyethylene, chairs and bars top designed for life in the open air.





Classe by Yonoh Studio





Möwee Outdoor **Classe**







Möwee Outdoor **Classe**



Classe by Yonoh Studio









Classe by Yonoh Studio





Classe by Yonoh Studio



# LACE

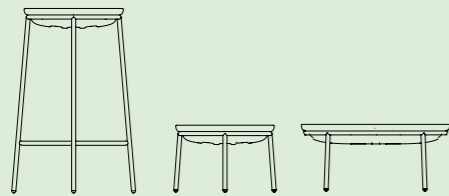
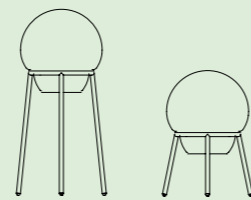
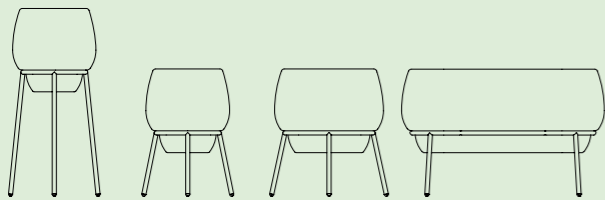
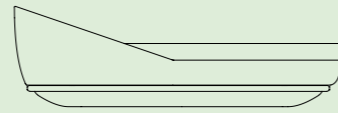
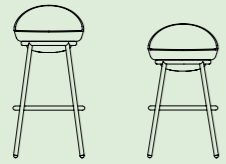
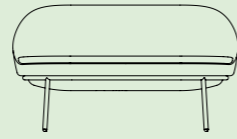

**Calma, comodidad y ligereza. Sus volúmenes y cantos redondeados conseguidos por rotomoldeo, hacen de ella una colección amable y atractiva. Una combinación perfecta de materiales. Textil, que aporta confort y diseño, junto al metal, que reduce la cantidad de polietileno y equilibra el peso visual de sus piezas.**

Calm, comfort and lightness. The volumes and rounded edges are achieved by rotational moulding, making this collection both friendly and attractive. A perfect blend of materials. Textiles provide comfort and design alongside the metal, reducing the amount of polyethylene used and balancing the visual impact of the pieces.





Möwee Outdoor **Lace**



Lace by Yonoh Studio





Möwee Outdoor **Lace**



Lace by Yonoh Studio





Lace by Yonoh Studio





Möwee Outdoor **Lace**



Lace by Yonoh Studio





Lace by Yonoh Studio





Möwee Outdoor **Lace**



Lace by Yonoh Studio





Möwee Outdoor **Lace**



Lace by Yonoh Studio









Lace by Yonoh Studio





Möwee Outdoor **Lace**



Lace by Yonoh Studio





Möwee Outdoor **Lace**



Lace by Yonoh Studio





Lace by Yonoh Studio



# UNI

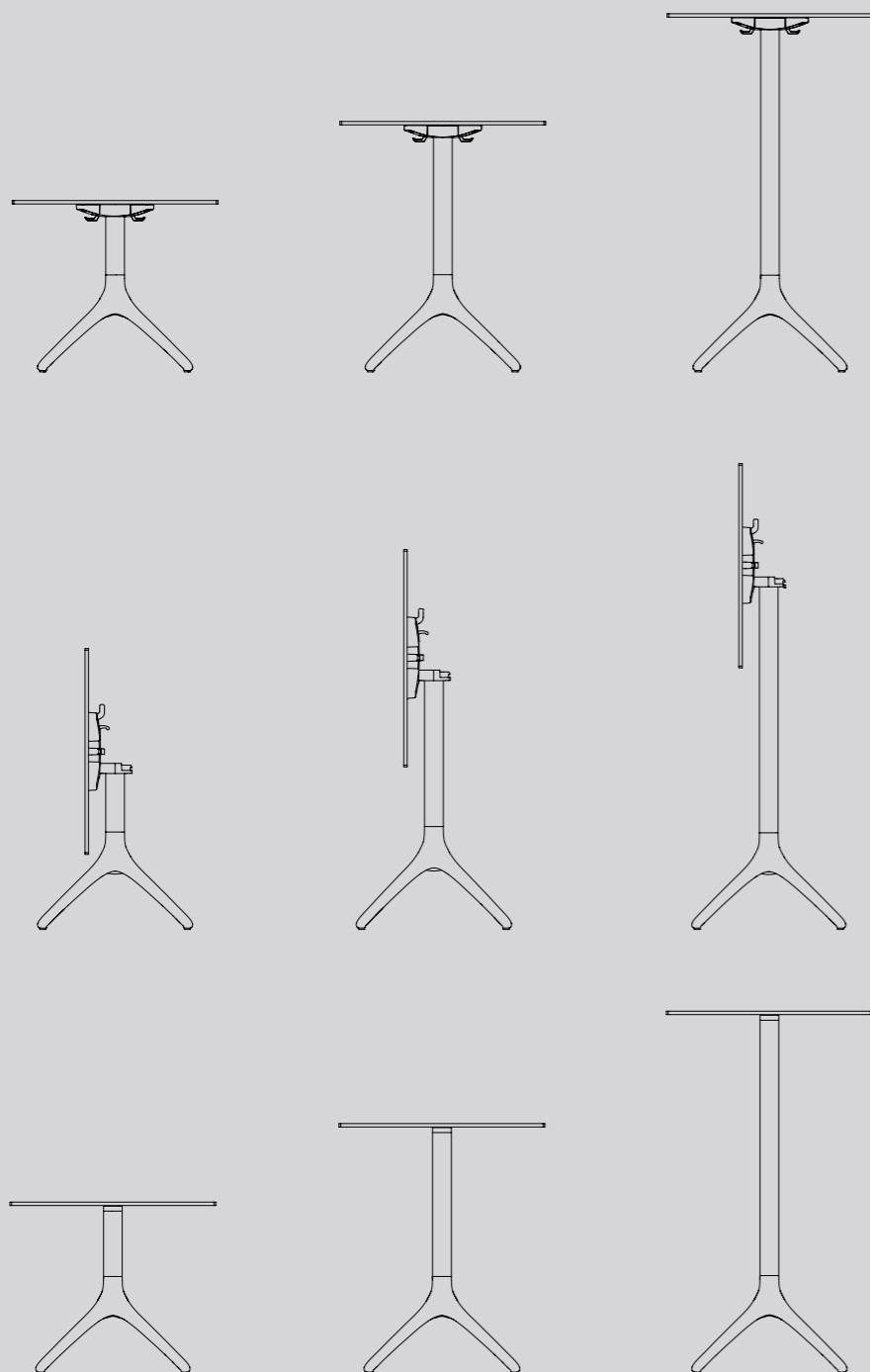

**Su razón de ser es la versatilidad. Mesas sencillas con estructura de aluminio de colores, materiales y formas diferentes. Un sinfín de posibilidades para todos los gustos. Calidad y durabilidad. Elegancia y delicadeza.**

Versatility is their hallmark style. Simple tables with aluminium structure in different colours, materials and forms. Endless possibilities for all tastes. Quality and durability. Elegance and finesse.





Möwee Outdoor **Uni**



Uniby Héctor Serrano





Möwee Outdoor **Uni**



100 101





Uniby Héctor Serrano





Möwee Outdoor **Uni**



104 105





Möwee Outdoor **Uni**



Uniby Héctor Serrano



# RIBBONS

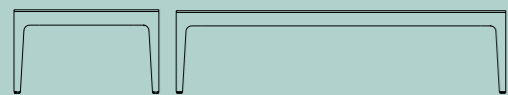
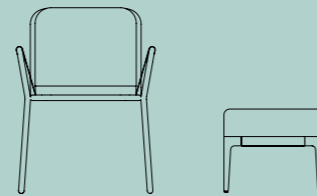
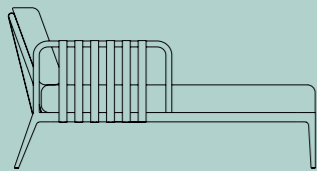
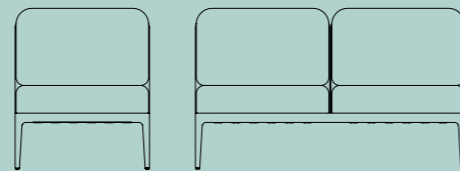
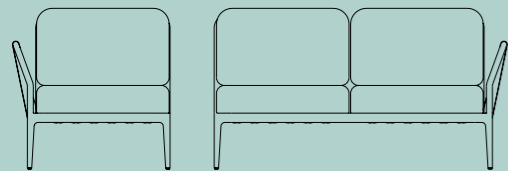
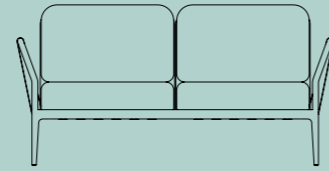
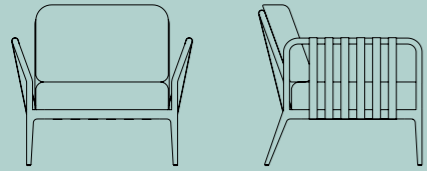

**Una colección inconfundible por su belleza y robustez.  
Homenaje a la tradición manufacturera valenciana como reto a la  
innovación, haciéndola sostenible y duradera.  
Una colección con detalles que la hacen única.  
Descubrimos su lado más representativo, Ribbons. Ingeniería y  
tradicón se unen, consiguiendo así una colección con carácter propio.**

An unmistakable collection for its beauty and robustness.  
A tribute to the Valencian manufacturing tradition as a challenge to  
innovation, making it sustainable and durable.  
A collection with details that make it unique.  
We discover its most representative side, Ribbons. Engineering and  
tradition come together, thus achieving a collection with its own character.









Möwee Outdoor **Ribbons**



112 113





Möwee Outdoor **Ribbons**





# COVER

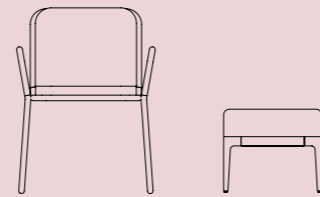
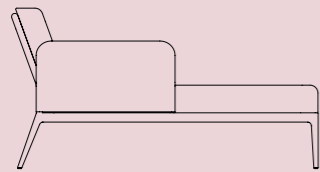
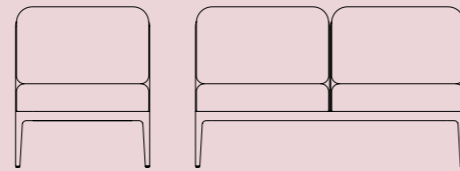
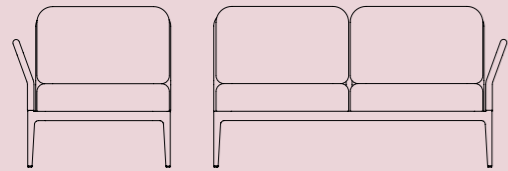
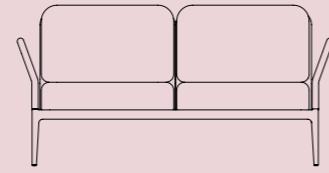
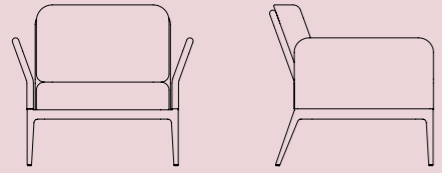

**Una colección inconfundible por su belleza y robustez. Homenaje a la tradición manufacturera valenciana como reto a la innovación, haciéndola sostenible y duradera. Elegancia. Sencillez. Comodidad. Una colección única, diferente, distinguida, con carácter. Un sinfín de colores para todos los gustos y espacios.**

An unmistakable collection for its beauty and robustness. A tribute to the Valencian manufacturing tradition as a challenge to innovation, making it sustainable and durable. Elegance. Simplicity. Comfort. A unique collection, different, distinguished, with character. An endless number of colors for all tastes and spaces.





Möwee Outdoor **Cover**

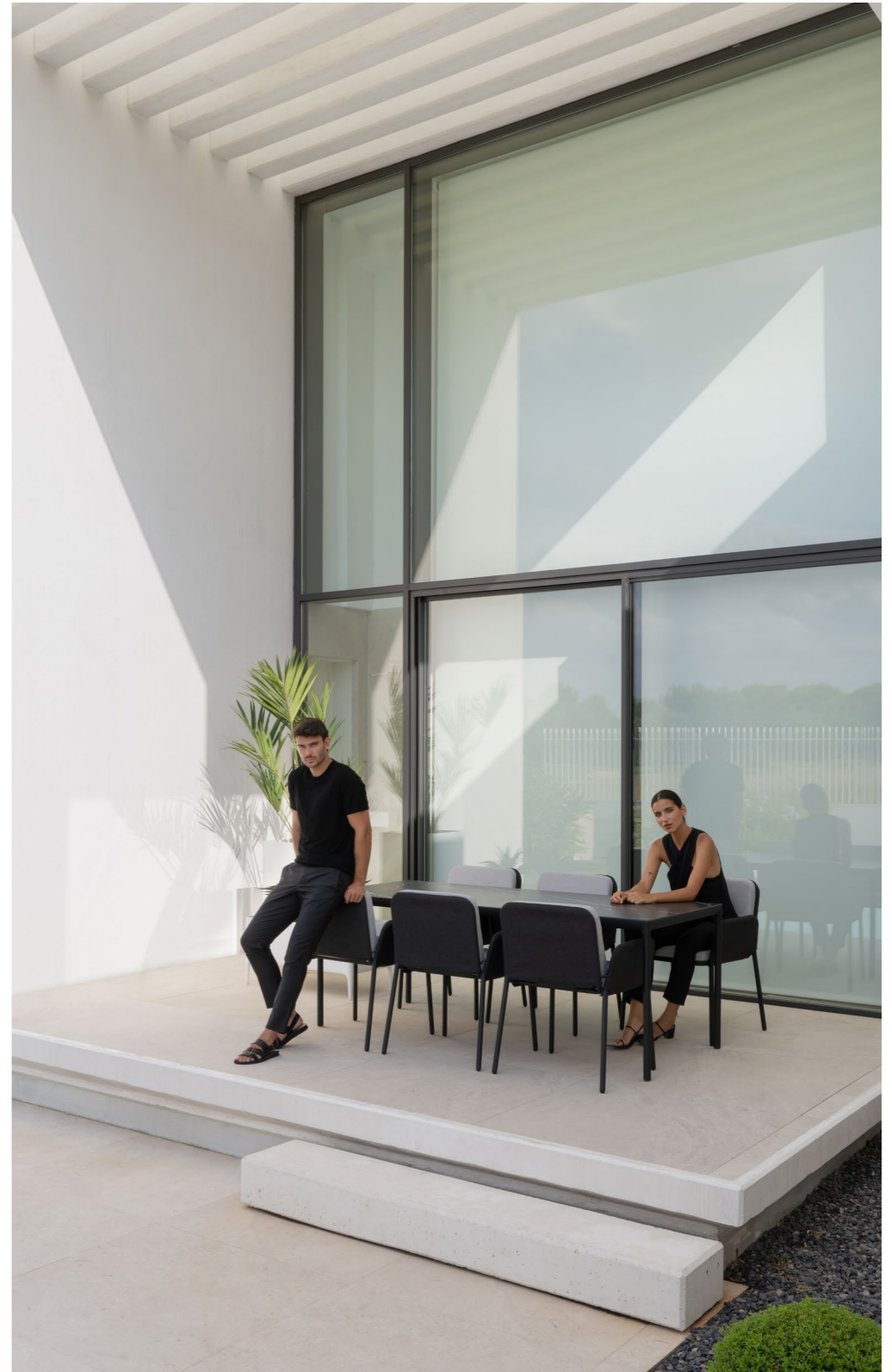





Cover by Bandada Studio





Möwee Outdoor **Cover**

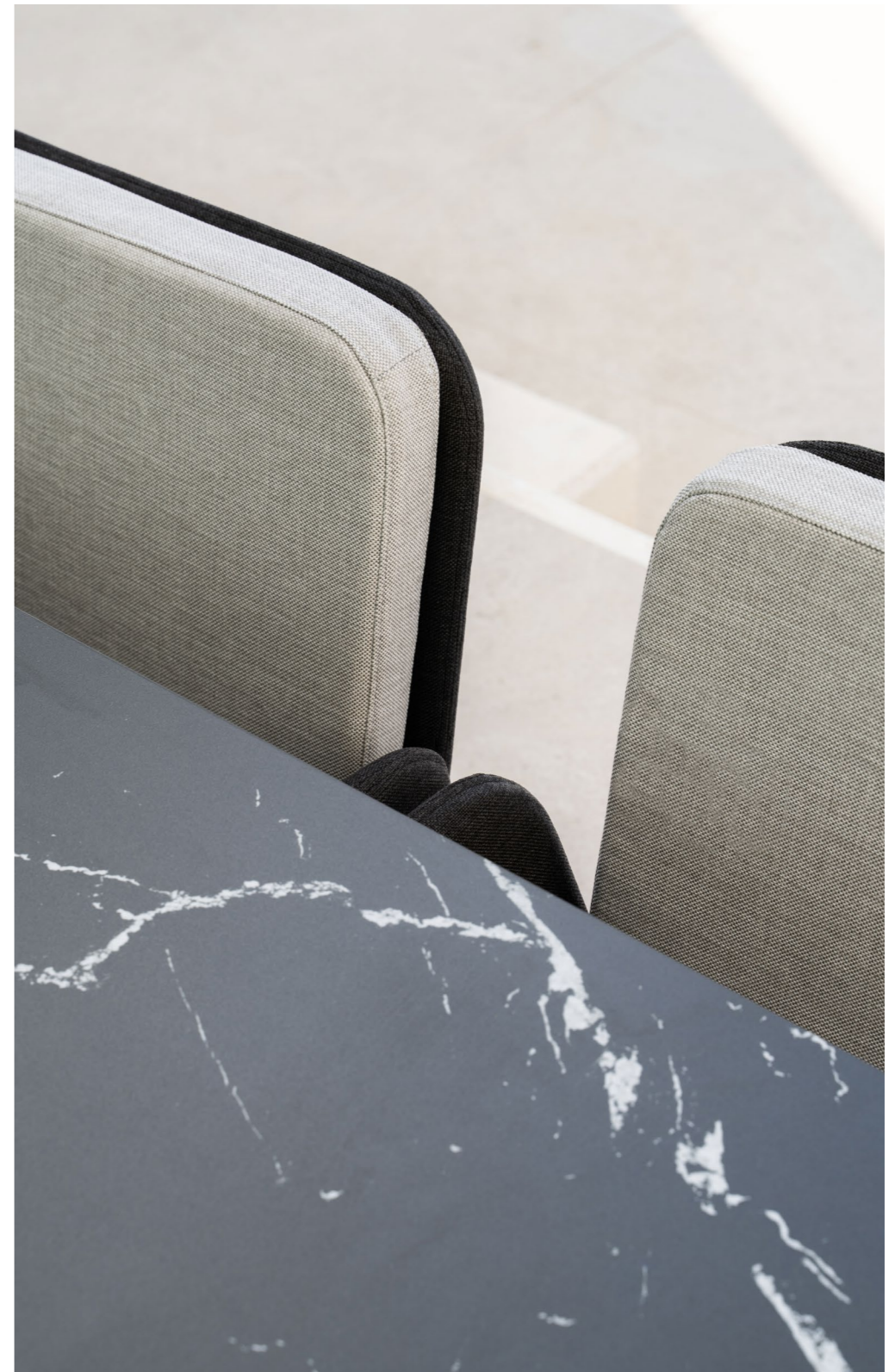

Cover by Bandada Studio





Möwee Outdoor **Cover**



**Cover** by Bandada Studio



# NATURE

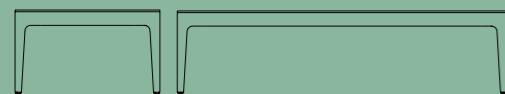
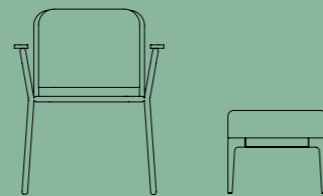
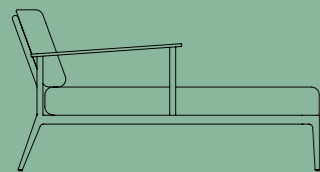
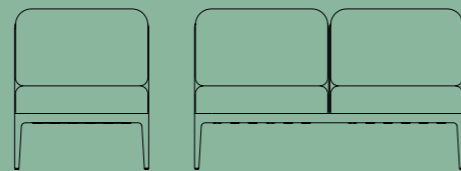
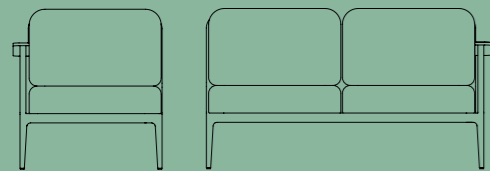
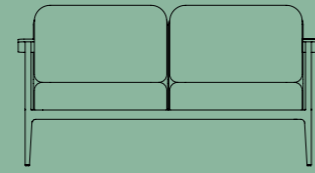
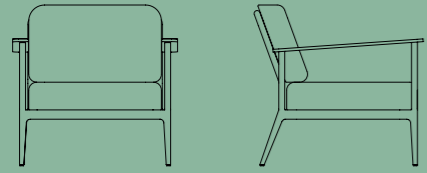

**Una colección inconfundible por su belleza y robustez. Homenaje a la tradición manufacturera valenciana como reto a la innovación, haciéndola sostenible y duradera. Una versión más fresca, Nature. Presenta toques de madera natural y sostenible, que otorga calidez y comodidad, y hace de ella una colección única.**

An unmistakable collection for its beauty and robustness. A tribute to the Valencian manufacturing tradition as a challenge to innovation, making it sustainable and durable. A fresher version, Nature. It presents touches of natural and sustainable wood, which gives warmth and comfort, and makes it a unique collection.





Nature by Bandada Studio





Möwee Outdoor **Nature**



**Nature** by Bandada Studio







# BREZ

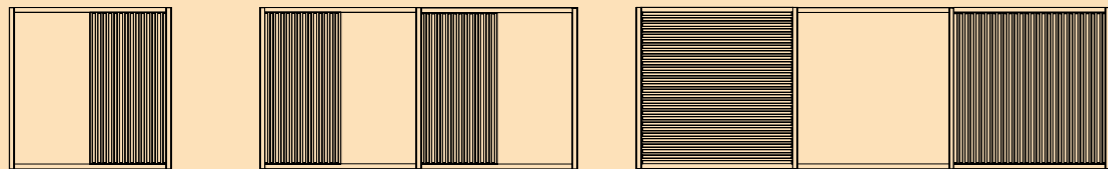
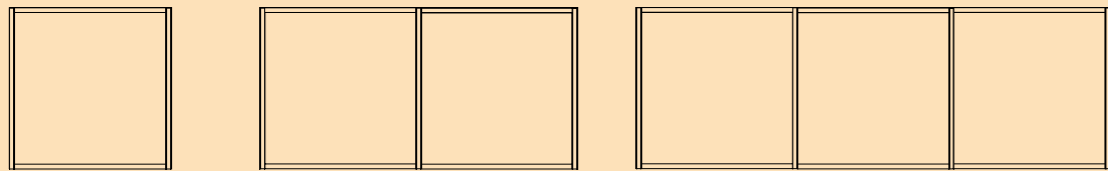
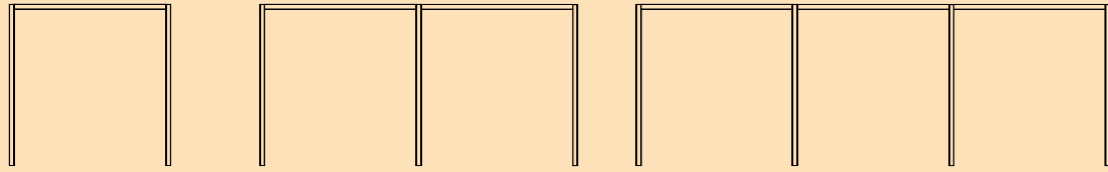

**Equilibrio entre diseño y arquitectura de vanguardia.  
Espacios de autor. La posibilidad de hacer tuyo cualquier  
entorno, gracias a nuestras estructuras modulares con  
diferentes acabados, colores, dimensiones, iluminación y  
otros complementos.**

Balance between cutting edge design and architecture.  
Signature spaces. The chance to put your own stamp on any  
space, using our modular structures in a range of finishes,  
colours dimensions, illumination and accessories.





Brez by Bandada





Möwee Outdoor **Brez**



**Brez** by Bandada





Brez by Bandada





Möwee Outdoor **Brez**



142 143





Brez by Bandada



TECHNICALS



# XALOC

Héctor Serrano

**Butaca** Armchair

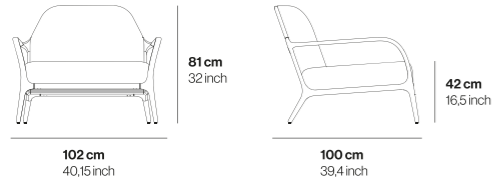

**Sofá** Sofa

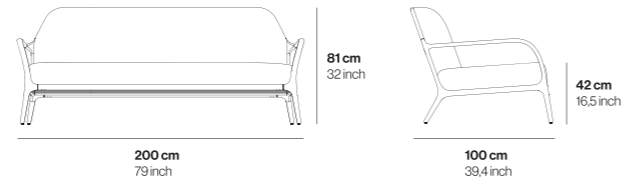

**Chaise Longue** Chaise Longue

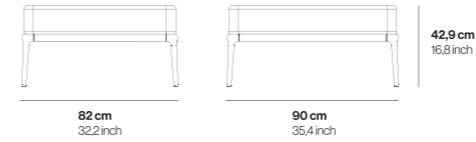

**Tumbona** Sunchair

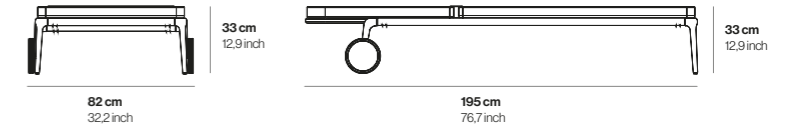

**Derecho 90** 90 Right

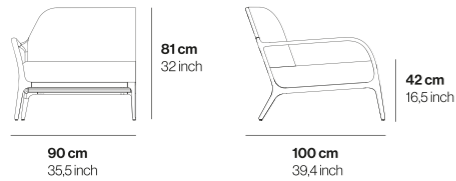

**Derecho 160** 160 Right

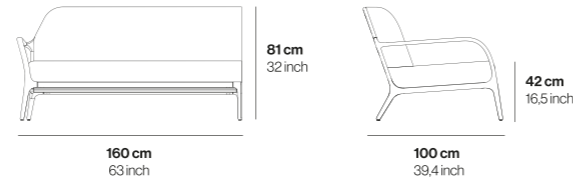

**Puff 50** 50 Puff

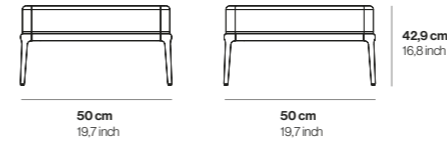

**Mesa 120** 120 Table

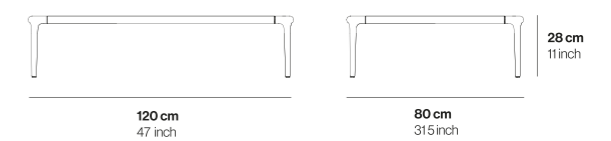

**Central 90** 90 Central

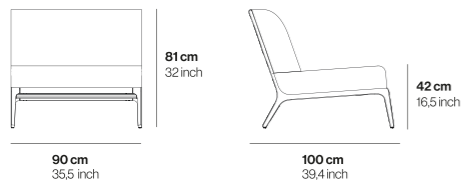

**Central 160** 160 Central

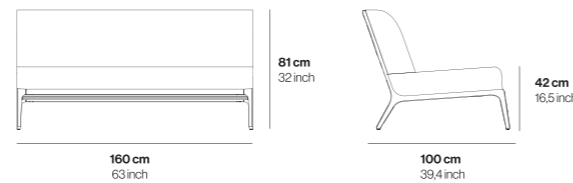

**Mesa 80** 80 Table

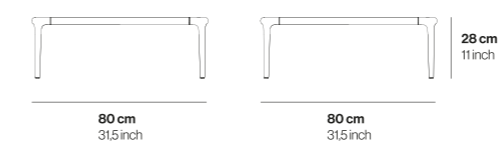

**Mesa 50** 50 Table

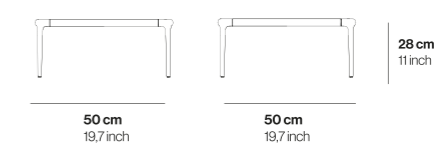

**Izquierdo 90** 90 Left

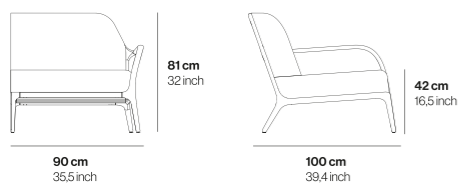

**Izquierdo 160** 160 Left

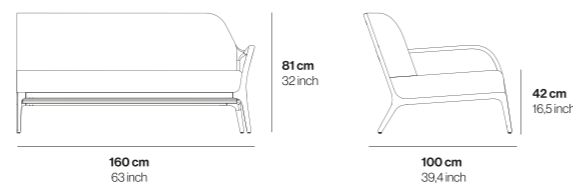

**Mesa 200** 200 Table

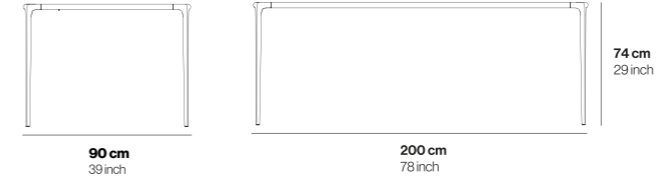

**Mesa 160** 160 Table

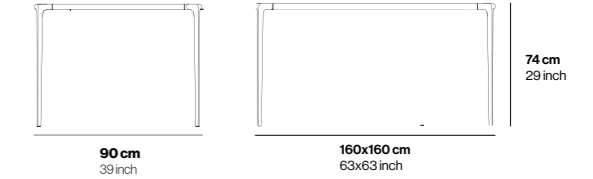



# XALOC

Héctor Serrano

Mesa 140 140 Table

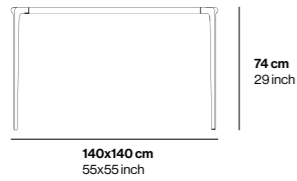

Mesa 90 90 Table

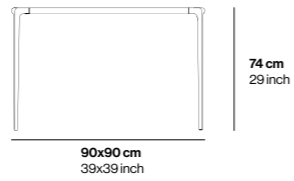

Mesa 70 70 Table

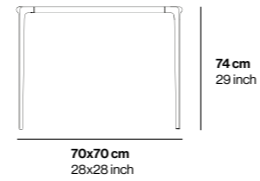

Maceta 45x45 45x45 Pot

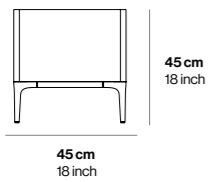

Jardinera Planter

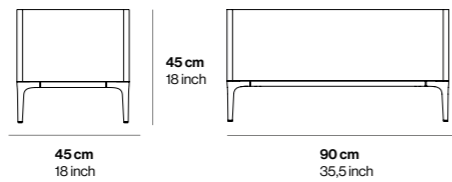

Maceta 45x90 45x90 Pot

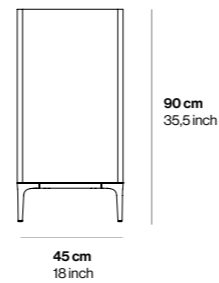

## Acabados Finishes

(\*) Colores, tejidos y tableros disponibles a partir de abril 2023  
 (\*) Colours, fabrics and boards available from April 2023

### Estructura Frame

#### Aluminio Lacado Lacquered Aluminum



### Textil Fabrics

#### Vita \*



#### Tales \*



#### Bruma \*

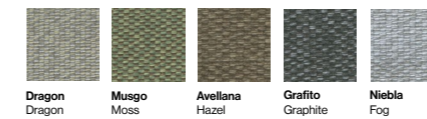

#### Asgard \*



#### Dolce



#### Panama



### Tableros Tabletop

#### HPL 10 mm HPL 10 mm

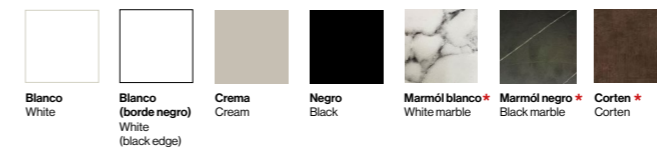

#### HPL 12 mm HPL 12 mm

#### Vidrio templado Tinted tempered Glass

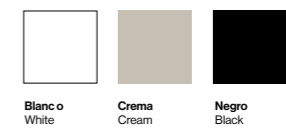

#### Dekton Dekton \*

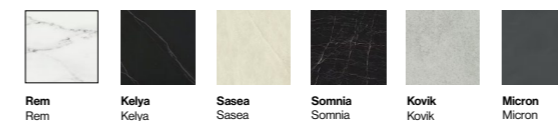



# XALOC

Héctor Serrano  
OPTIONAL COMBINATIONS

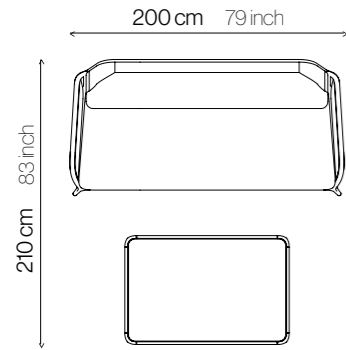

## Xaloc 1

1 x Sofá  
1 x Mesa 120 / 120 Table

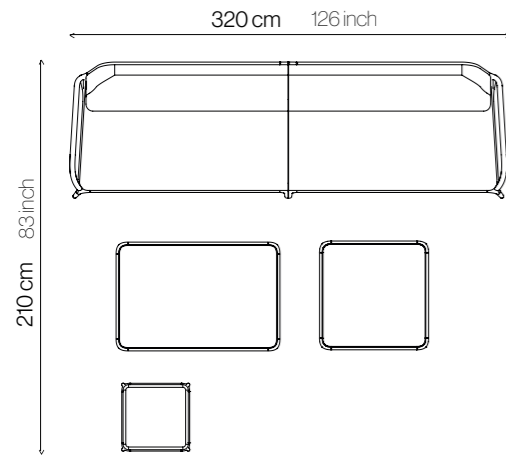

## Xaloc 2

1 x Izquierdo 160 / 160 Left  
1 x Derecho 160 / 160 Right  
1 x Mesa 120 / 120 Table  
1 x Mesa 80 / 80 Table  
1 x Puff 50 / 50 Puff

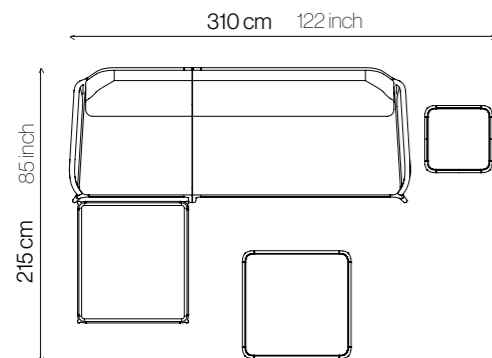

## Xaloc 3

1 x Izquierdo 160 / 160 Left  
1 x Derecho 90 / 90 Right  
1 x Chaise Longue  
1 x Mesa 80 / 80 Table  
1 x Mesa 50 / 50 Table

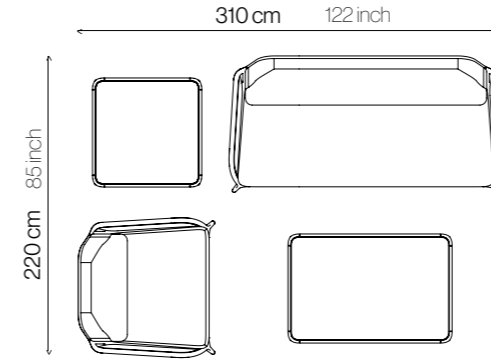

## Xaloc 4

1 x Sofá  
1 x Butaca / Armchair  
1 x Mesa 120 / 120 Table  
1 x Mesa 80 / 80 Table

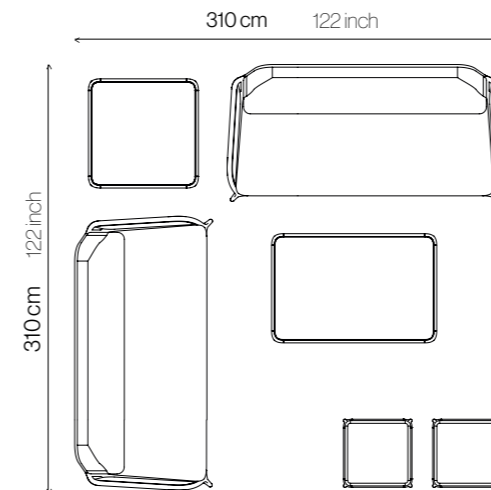

## Xaloc 5

2 x Sofá  
1 x Mesa 120 / 120 Table  
1 x Mesa 80 / 80 Table  
2 x Puff 50 / 50 Puff

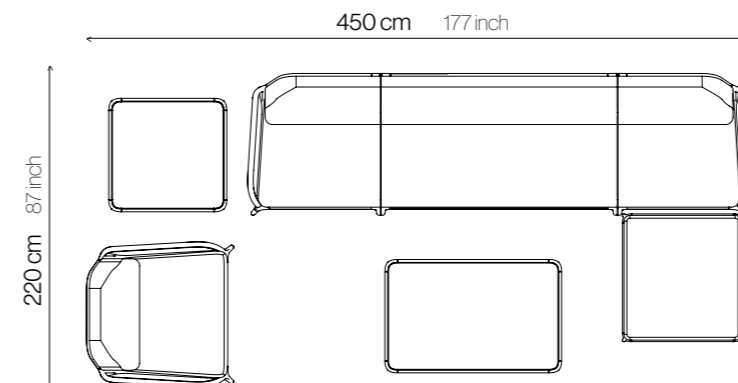

## Xaloc 6

1 x Derecho 90 / 90 Right  
1 x Izquierdo 90 / 90 Left  
1 x Central 160 / 160 Central  
1 x Chaise Longue  
1 x Mesa 120 / 120 Table  
1 x Mesa 80 / 80 Table  
1 x Butaca / Armchair



# CLASSE

(\*) Colores disponibles a partir de abril 2023  
(\*) Colours available from April 2023

Yonoh Studio

## Silla Classe Classe Chair

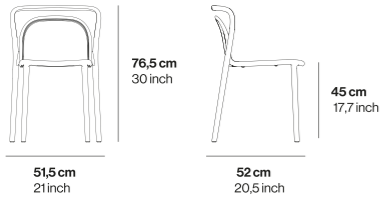

## Sillón Classe Classe Armchair

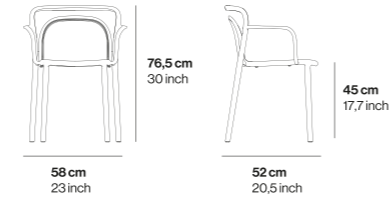

## Silla Classe Slats Slats Classe Chair

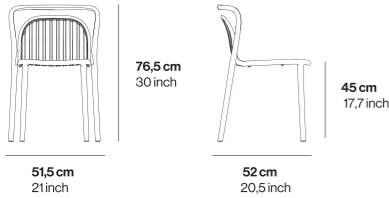

## Sillón Classe Slats Slats Classe Armchair

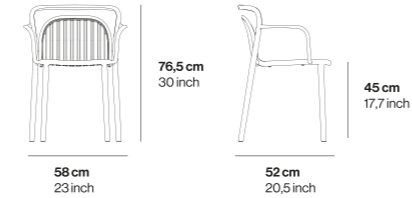

### Acabados Finishes

#### Estructura Frame



#### Textil acolchado Stuffing fabrics

Para elegir el tejido del cojín, ver página 182  
To choose the cushion fabric, see page 182

## Bar Classe recto Straight Classe Bar

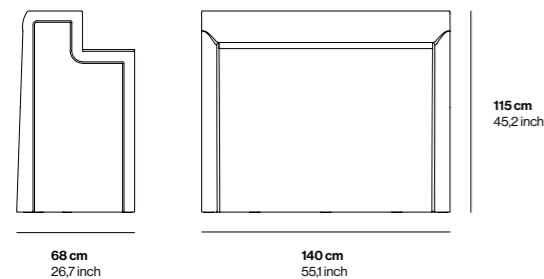

## Bar Classe curvo Curved Classe Bar

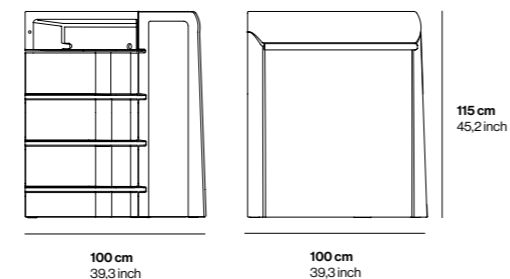

### Acabados Finishes

#### Básico Basic / Lacado Lacquered / Iluminación perfil LED Profile LED Lighting



#### Retroiluminado Backlit

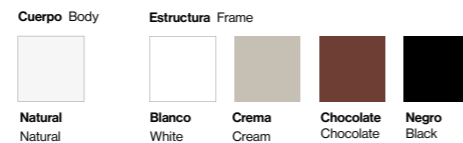

# LACE

Yonoh Studio

## Butaca Loungechair

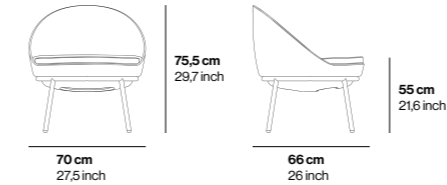

## Sofá Sofa

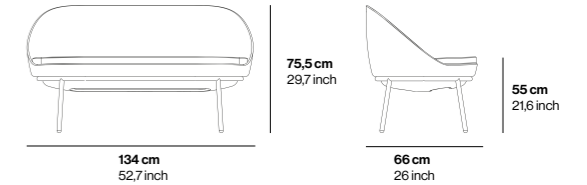

## Daybed Daybed

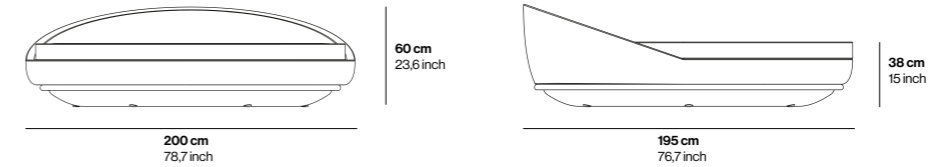

### Textil acolchado Stuffing fabrics

Para elegir el tejido del cojín, ver página 182  
To choose the cushion fabric, see page 182

## Taburete 90 90 Stool

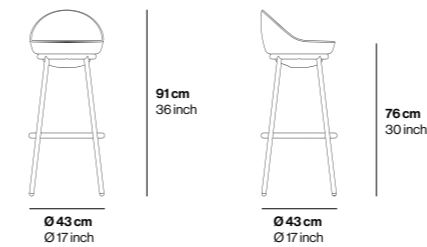

## Taburete 80 80 Stool

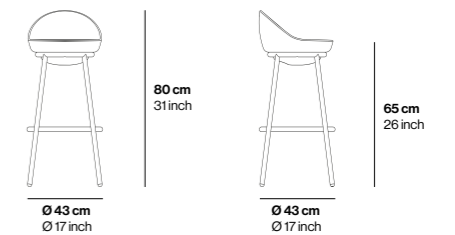

## Mesa 60x90 Low 60 x 90 Low Table

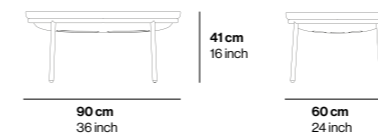

## Mesa 60 Low 60 Low Table

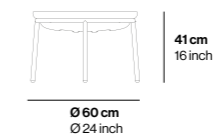

## Mesa 60 High 60 High Table

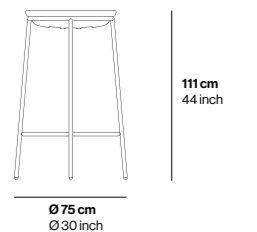



# LACE

Disponible en acabado retroiluminado  
Backlit finish available

Yonoh Studio

**Maceta 50 High** 50 High Pot

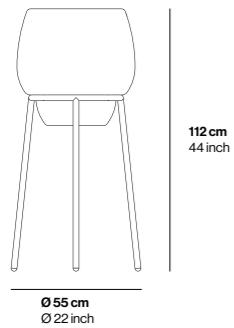

**Maceta 50 Low** 50 Low Pot

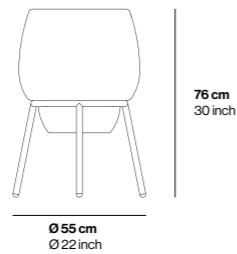

**Maceta 65** 65 Pot

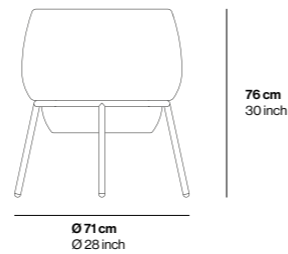

**Jardinera** Planter

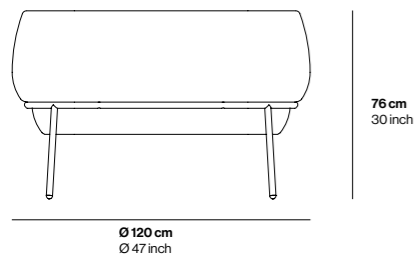

**Lámpara 50 Low** 50 Low Lamp

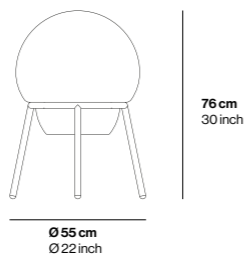

**Lámpara 50 High** 50 Low High

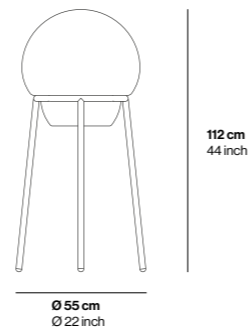

**Bar Lace Recto** Straight Lace Bar

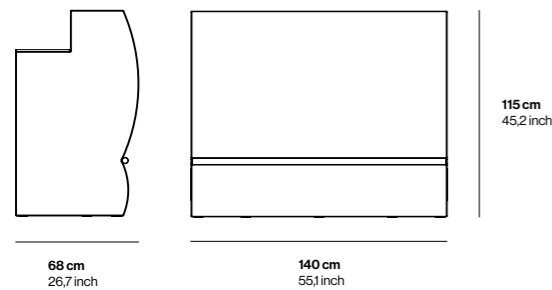

**Bar Lace Curvo** Curved Lace Bar

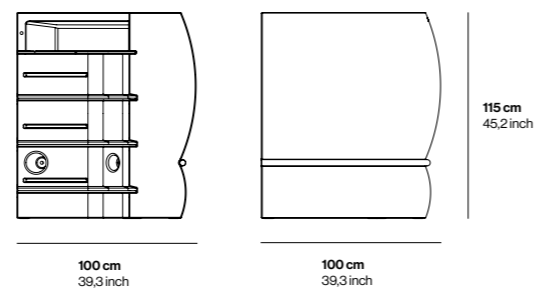

## Acabados Finishes

### Colores Colors

**Básico** Basic / **Lacado** Lacquered  
**Iluminación perfil LED** Profile LED Lighting



### Retroiluminado Backlit

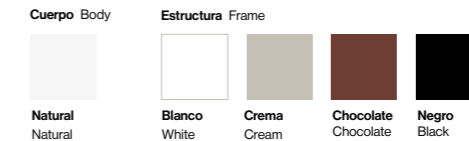

(\*) Colores y tejidos disponibles a partir de abril 2023  
(\*) Colours and fabrics available from April 2023

### Textil acolchado

#### Vita \*

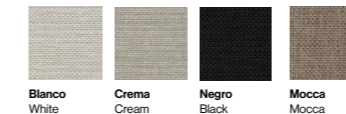

#### Bruma \*

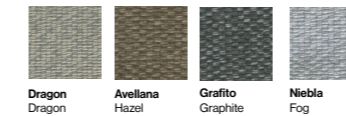

#### Dolce



#### Panama

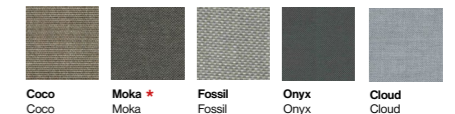

#### Tales \*



#### Asgard \*





# UNI

Héctor Serrano

## Abatible 50 50 Folding

## Abatible 73 73 Folding

## Abatible 105 105 Folding

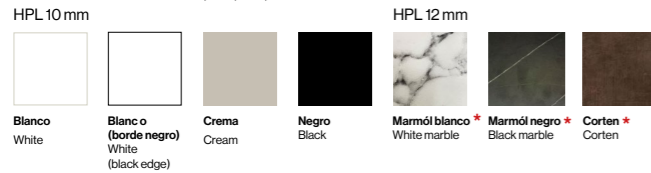
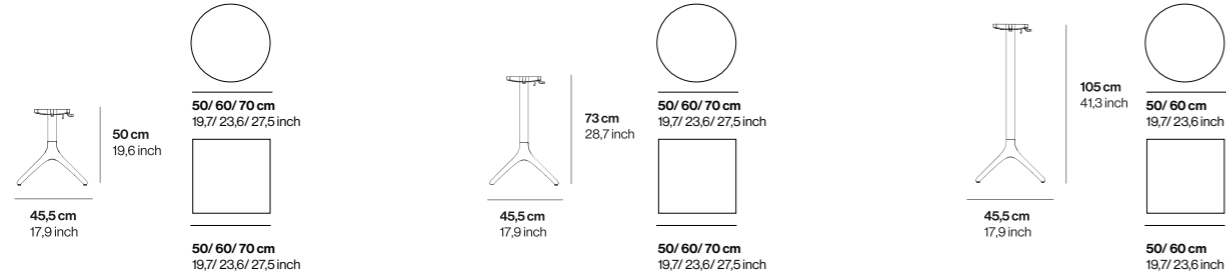

## Fijo 50 50 Fixed

## Fijo 73 73 Fixed

## Fijo 105 105 Fixed

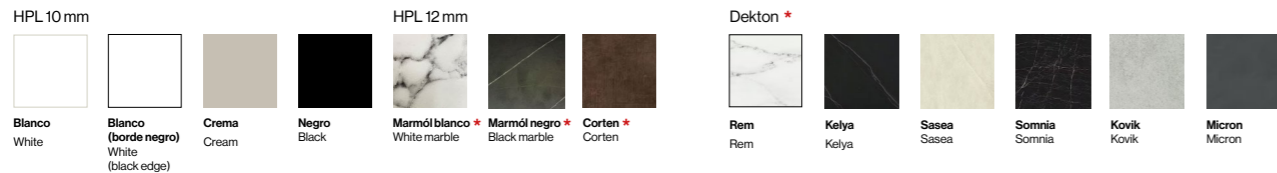
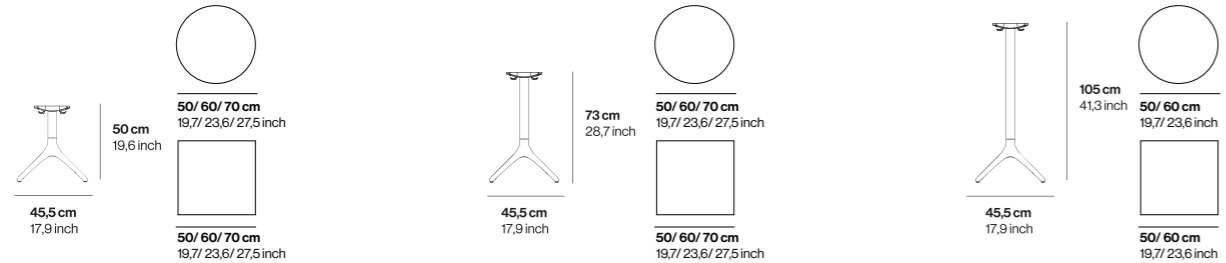

## Fijo para vidrio 50 50 Glass Fixed

## Fijo para vidrio 73 73 Glass Fixed

## Fijo para vidrio 105 105 Glass Fixed

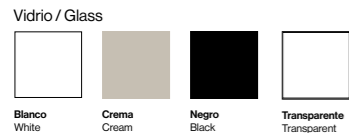
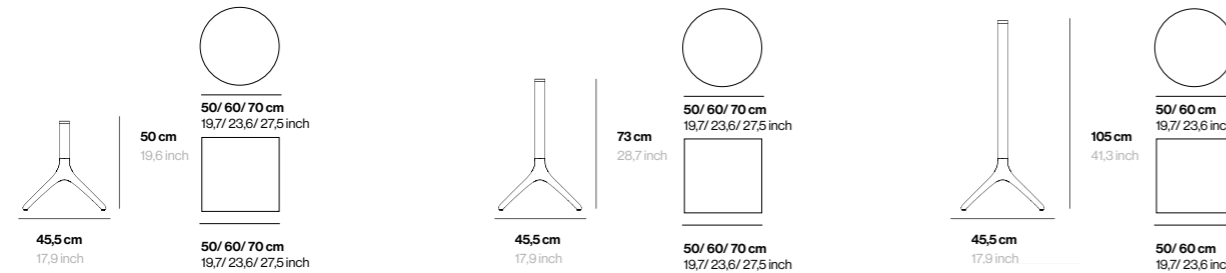

# UNI XL

Héctor Serrano

## Fijo 50 XL 50 Fixed XL

## Fijo 73 XL 73 Fixed XL

## Fijo 105 XL 105 Fixed XL

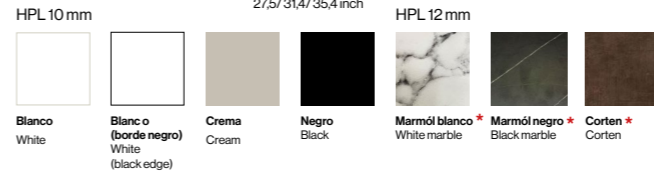
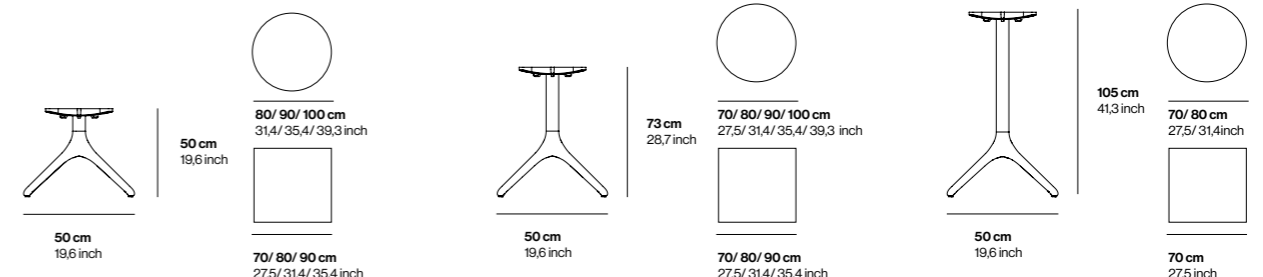

## Fijo cerámico 50 XL 50 Ceramic Fixed XL

## Fijo cerámico 73 XL 73 Ceramic Fixed XL

## Fijo cerámico 105 XL 105 Ceramic Fixed XL

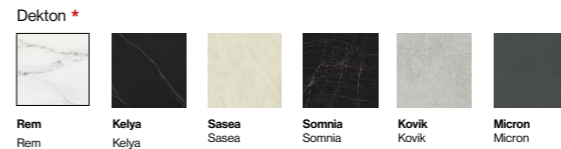
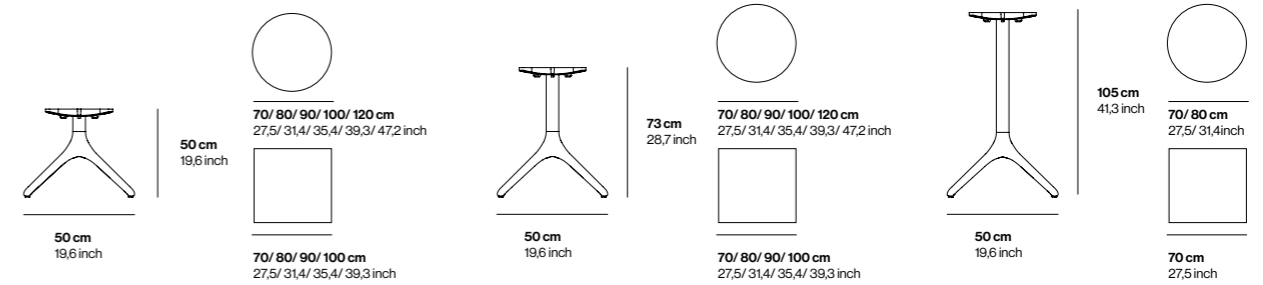

## Fijo vidrio 50 XL 50 Glass Fixed XL

## Fijo vidrio 73 XL 73 Glass Fixed XL

## Fijo vidrio 105 XL 105 Glass Fixed XL

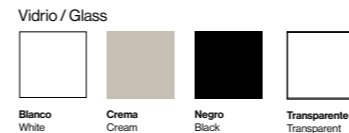
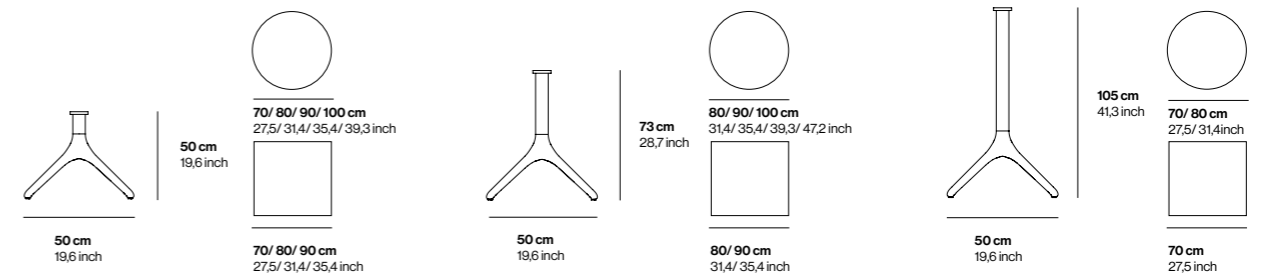



# RIBBONS

Bandada Studio

**Butaca** Longue chair

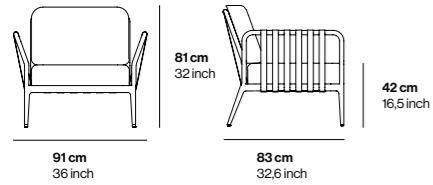

**Derecho** Right

**Sofá** Sofa

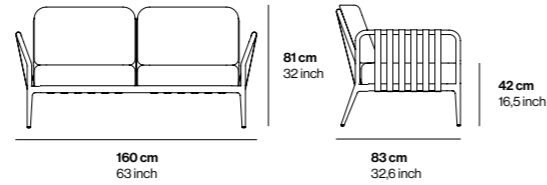

**Derecho doble** Double right

**Divano** Divan

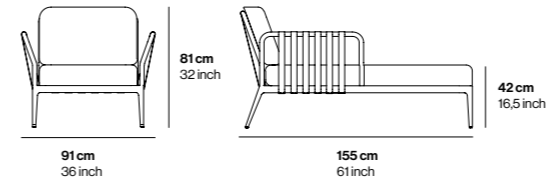

**Sillón** Armchair

**Esquinero** Corner

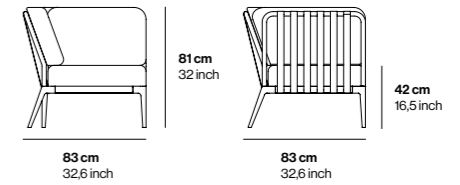

**Puff** Puff

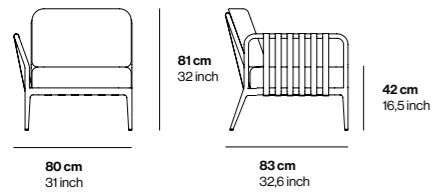

**Central** Central

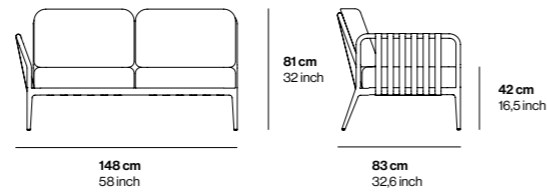

**Central doble** Double central

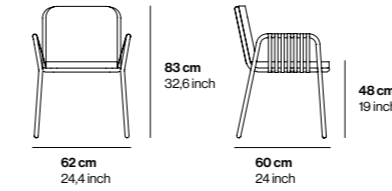

**Mesa 50** 50 Table

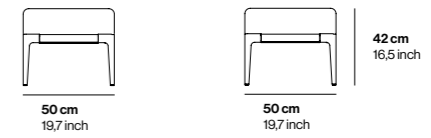

**Mesa 115** 115 Table

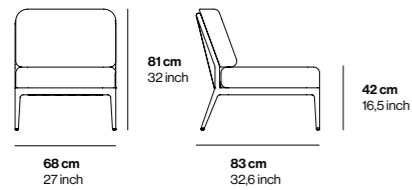

**Izquierdo** Left

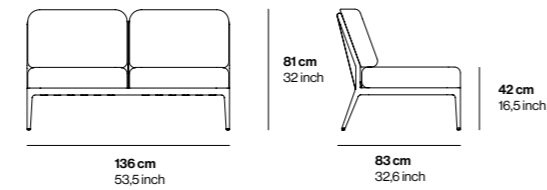

**Izquierdo doble** Double left

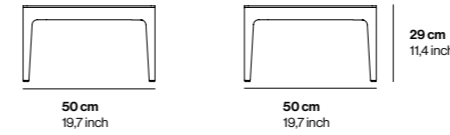

**Mesa 76** 76 Table

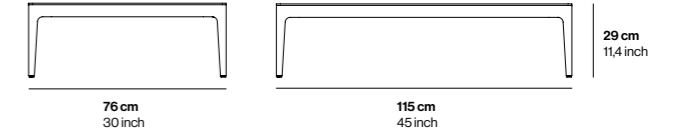

**Mesa 70** 70 Table

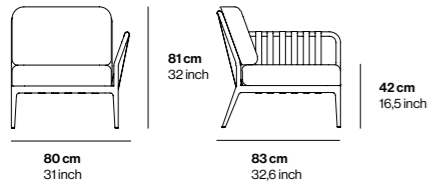

**Chaise longue derecho** Right chaiselongue

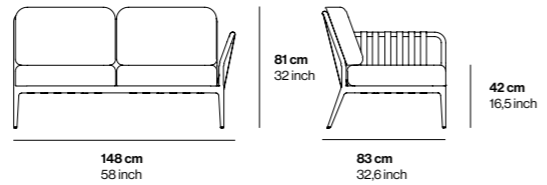

**Chaise longue izquierdo** Left chaiselongue

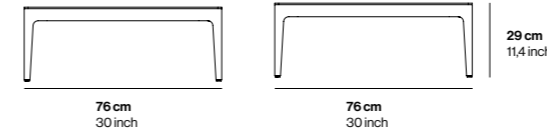

**Mesa 90** 90 Table

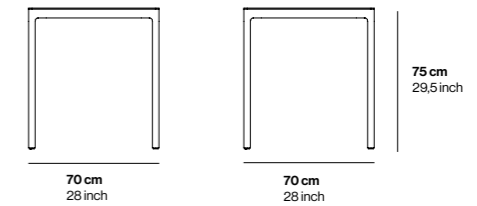

**Mesa 138** 138 Table

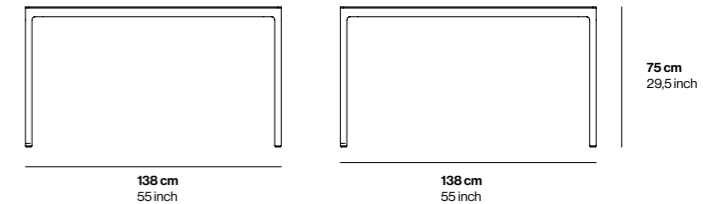
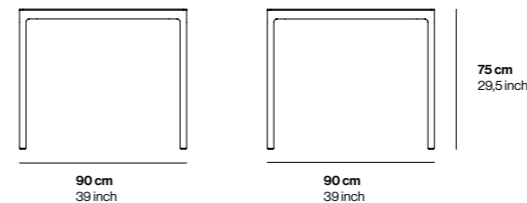
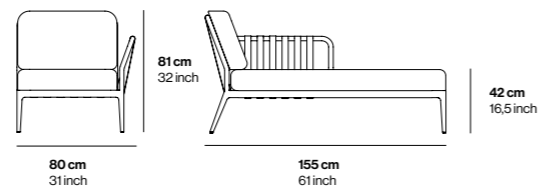
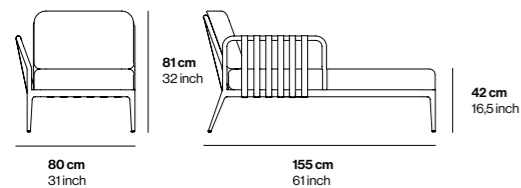

160 161



# RIBBONS

## Mesa 160 160 Table

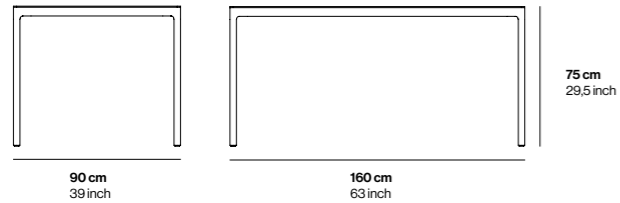

## Mesa 200 200 Table

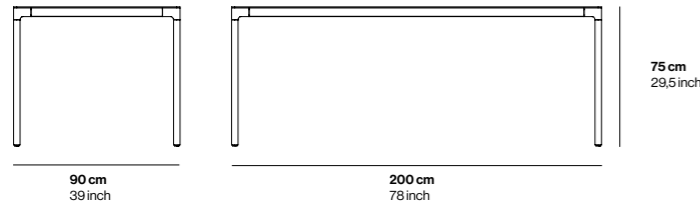

## Mesa 250 250 Table

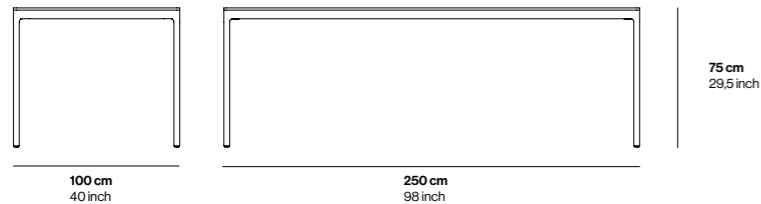

## Mesa 300 300 Table

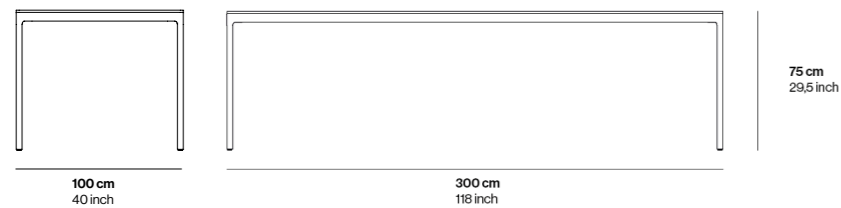

## Acabados Finishes

(\*) Colores, tejidos y tableros disponibles a partir de abril 2023  
 (\*) Colours, fabrics and boards available from April 2023

### Estructura Frame

#### Aluminio lacado Lacquered Aluminum

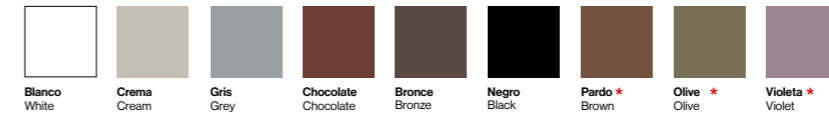

### Textil Fabrics

#### Vita \*

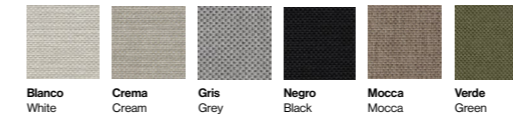

#### Bruma \*

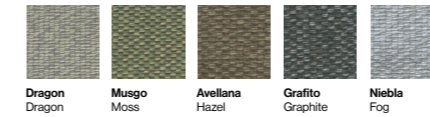

#### Dolce



#### Panama

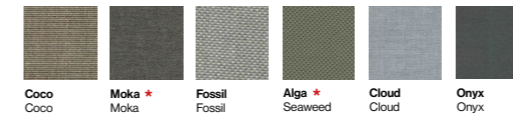

#### Tales \*

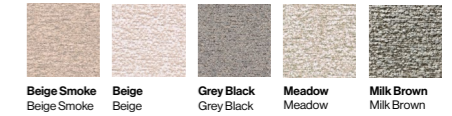

#### Asgard \*



#### Cintas Ribbons

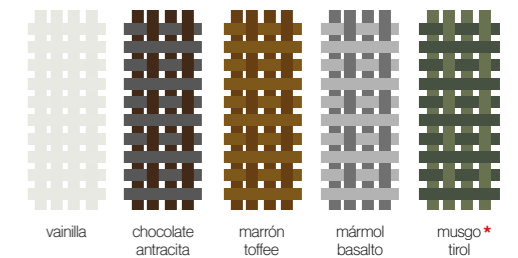

### Tableros Tabletop

#### HPL 10 mm HPL 10 mm

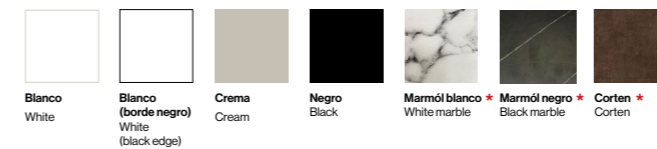

#### HPL 12 mm HPL 12 mm

#### Dekton Dekton \*

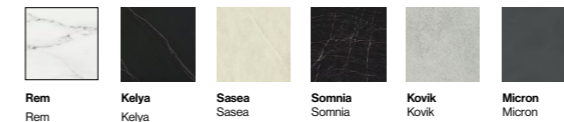



# COVER

Bandada Studio

**Butaca** Longue chair

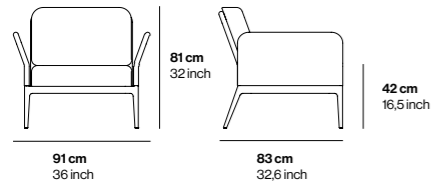

**Derecho** Right

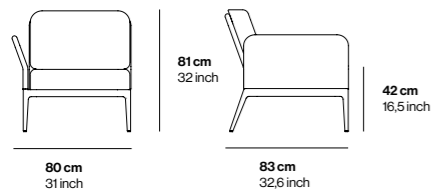

**Central** Central

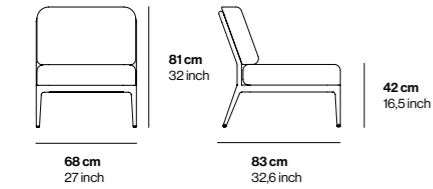

**Izquierdo** Left

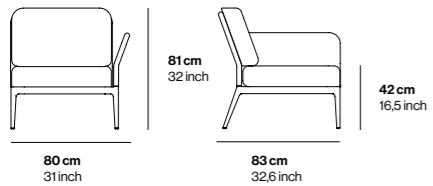

**Chaiselongue derecho** Right chaiselongue

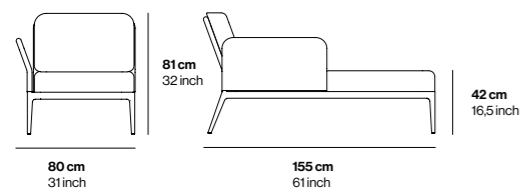

**Sofá** Sofa

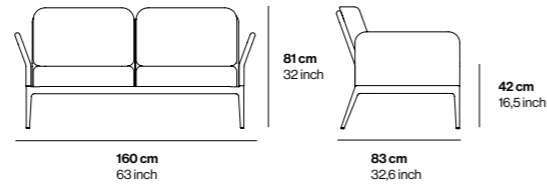

**Derecho doble** Double right

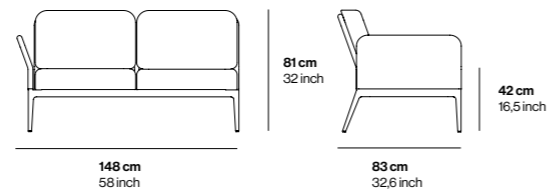

**Central doble** Double central

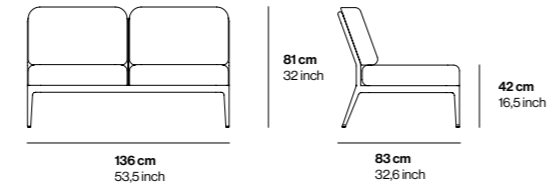

**Izquierdo doble** Double left

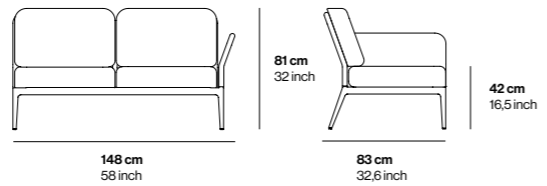

**Chaiselongue izquierdo** Left chaiselongue

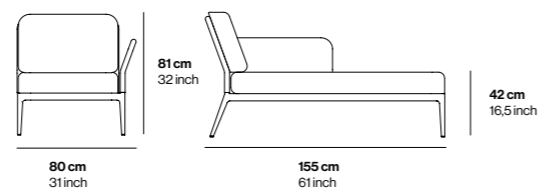

**Divano** Divan

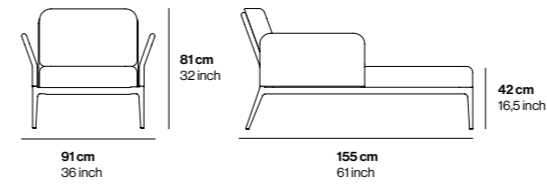

**Sillón** Armchair

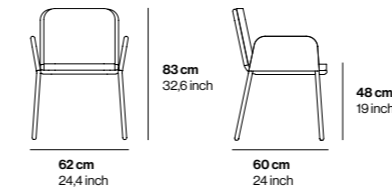

**Esquinero** Corner

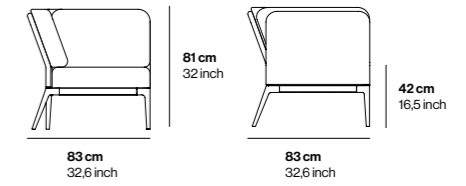

## Acabados Finishes

### Estructura Frame

#### Aluminio lacado Lacquered Aluminum

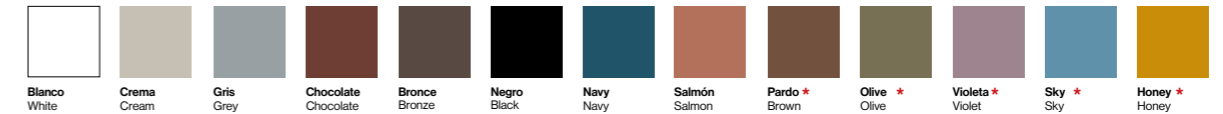

(\*) Colores y tejidos disponibles a partir de abril 2023  
(\*) Colours and fabrics available from April 2023

### Textil Fabrics

#### Vita \*



#### Bruma \*



#### Asgard \*



#### Dolce



#### Tales \*

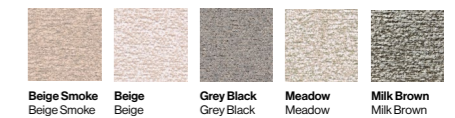

#### Panama

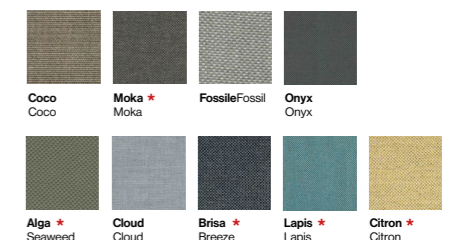



# NATURE

Bandada Studio

**Butaca** Longue chair

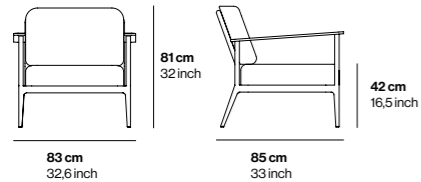

**Derecho** Right

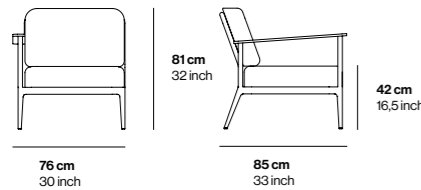

**Central** Central

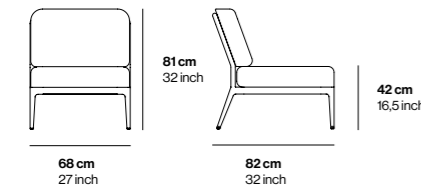

**Izquierdo** Left

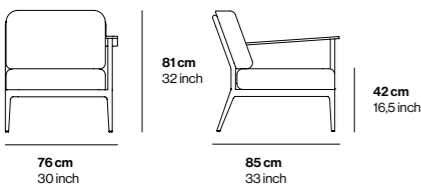

**Chaiselongue derecho** Right chaiselongue

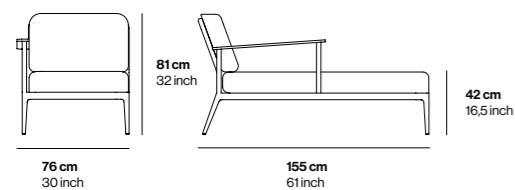

**Sofá** Sofa

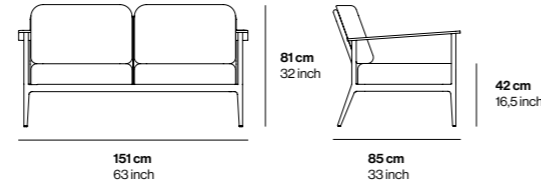

**Derecho doble** Double right

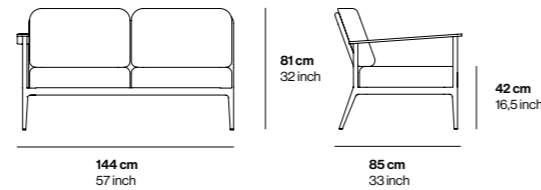

**Central doble** Double central

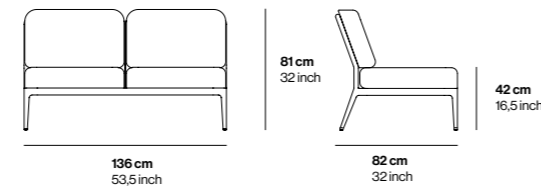

**Izquierdo doble** Double left

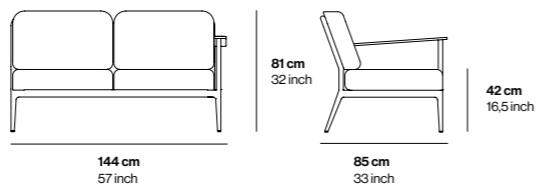

**Chaiselongue izquierdo** Left chaiselongue

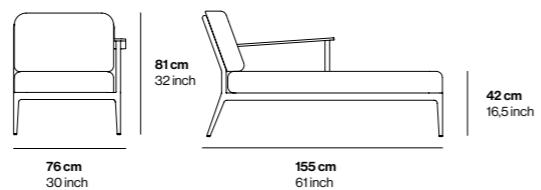

**Divano** Divan

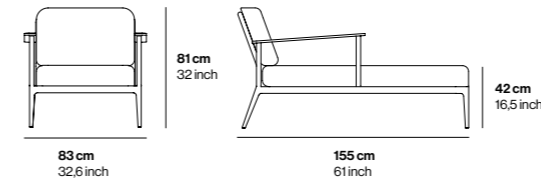

**Sillón** Armchair

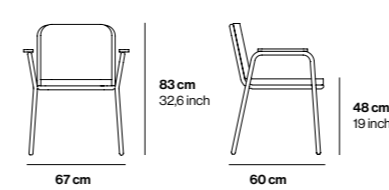

**Esquinero** Corner

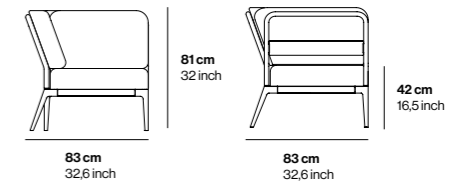

## Acabados Finishes

(\*) Colores y tejidos disponibles a partir de abril 2023  
(\* Colours and fabrics available from April 2023)

### Estructura Frame

#### Aluminio lacado Lacquered Aluminum

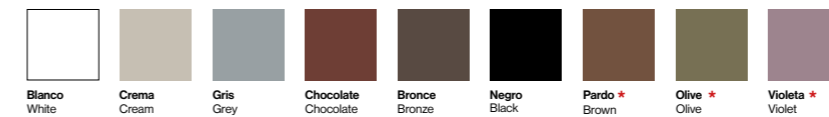

### Reposabrazos Armrest

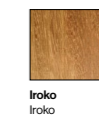

### Textil Fabrics

#### Vita \*

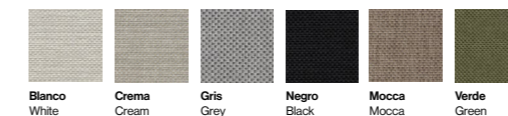

#### Bruma \*

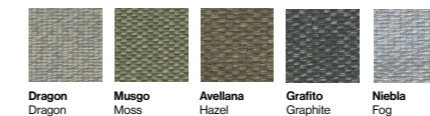

#### Asgard \*



#### Dolce



#### Tales \*

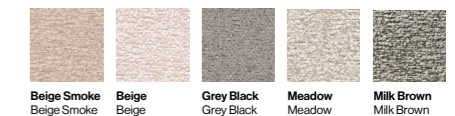

#### Panama

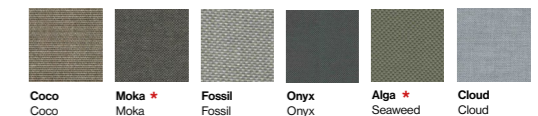



# BREZ

(\*) Colores disponibles a partir de abril 2023  
 (\*) Colours available from April 2023

Bandada Studio

## BREZ SIMPLE

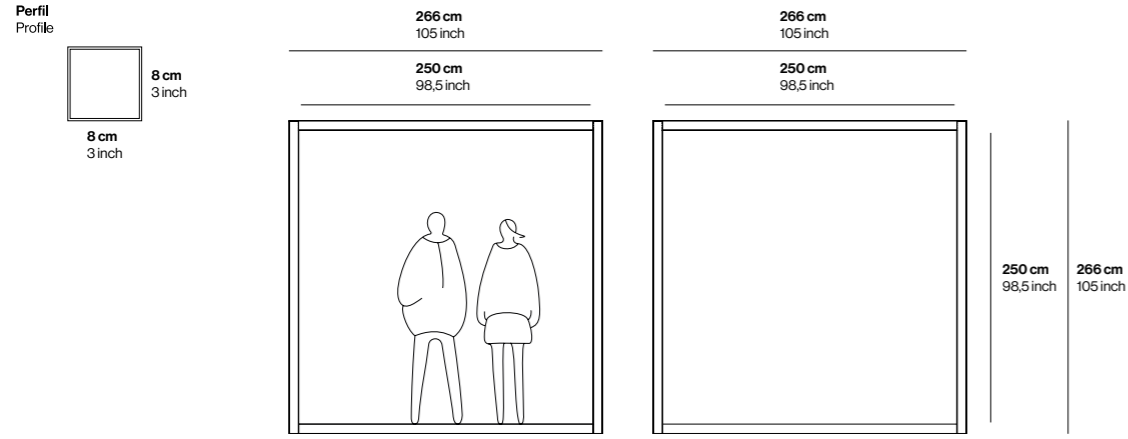

## BREZ TRIPLE

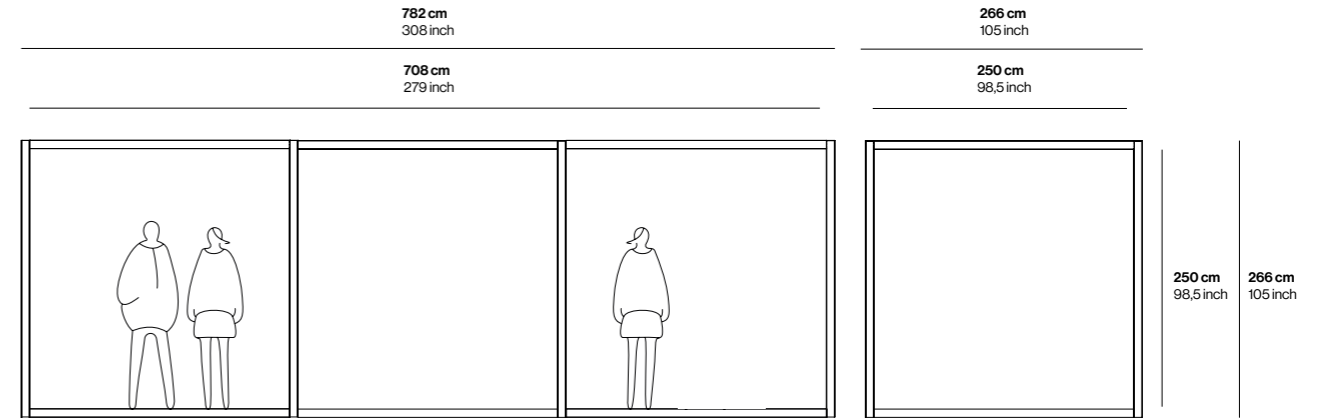

## BREZ DOBLE

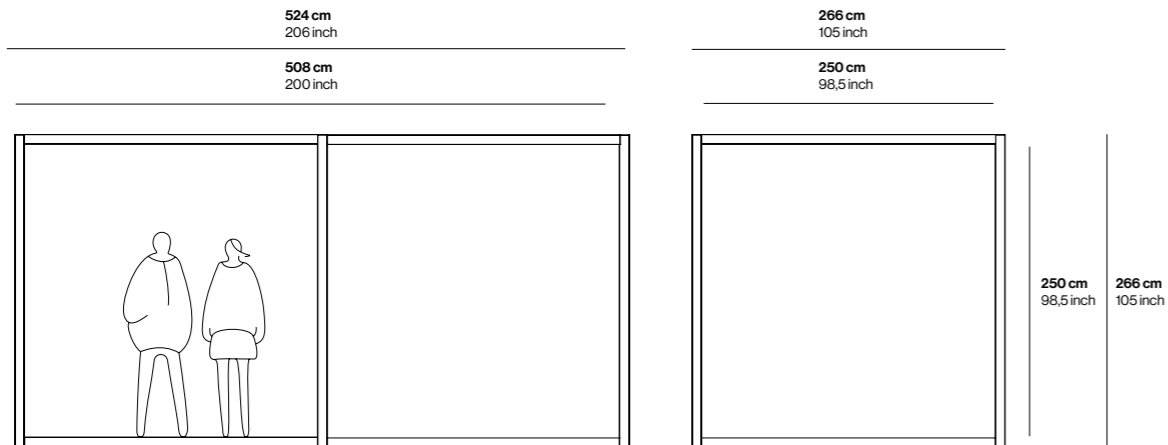

## Acabados Finishes

### Colores de estructura Structure colors

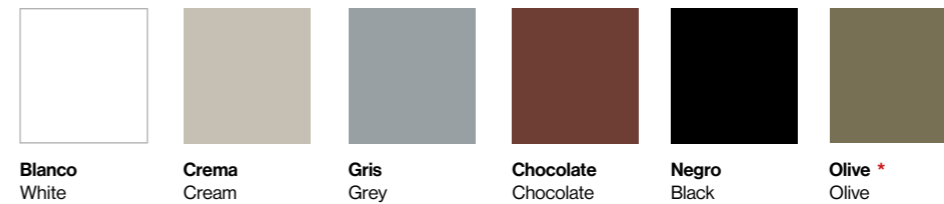



## TECHOS/ROOF



### Aluminio/ Aluminum

#### Techo celosía aluminio / Lattice aluminum roof

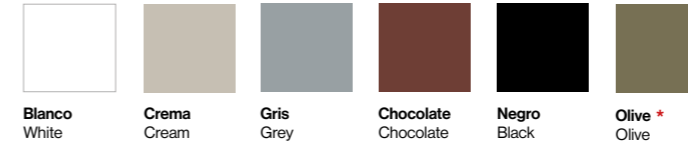

### Lona/ Canvas

#### Techo lona tensa motorizada / Motorized canvas roof

#### Techo palillera lona / Retractable roof

#### Soltis 96

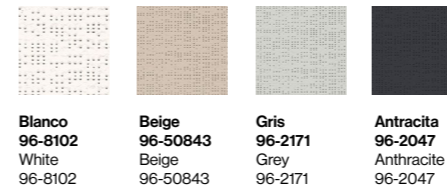

### Madera/ Wood

#### Techo celosía madera / Lattice wood roof

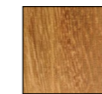

Iroko  
Iroko



Aluminio/Aluminium

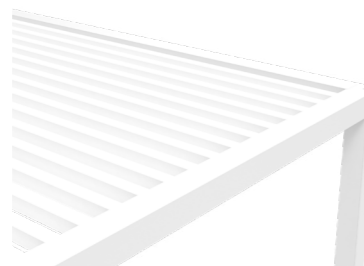

**Techo celosia aluminio**  
Lattice aluminium roof

Madera/Wood

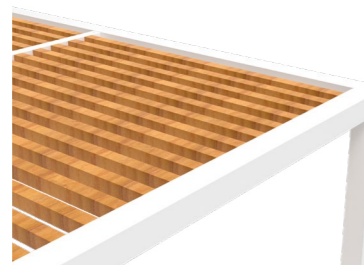

**Techo celosia madera**  
Lattice wood roof

Lona/Canvas

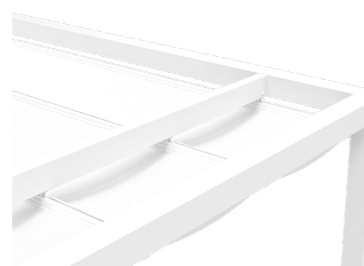

**Techo palillera motorizada**  
Retractable roof



**Techo lona tensa motorizada**  
Motorized canvas roof





# BREZ

(\*) Colores disponibles a partir de abril 2023  
(\*) Colours available from April 2023

Bandada Studio

## CELOSÍA/LATTICE

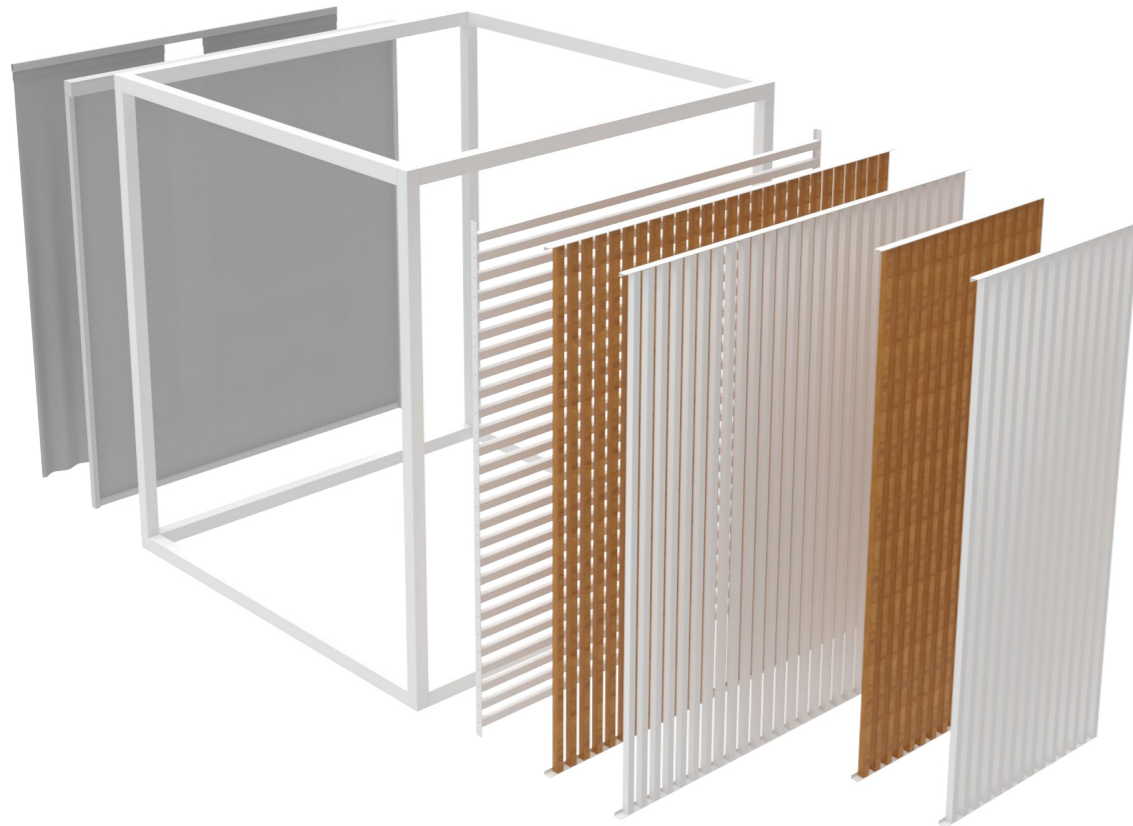

### Aluminio/ Aluminum

**Panel media celosía aluminio vertical** / Half lattice aluminum vertical panel

**Panel completo celosía aluminio vertical** / Full lattice aluminum vertical panel

**Panel completo celosía aluminio horizontal** / Full lattice aluminum horizontal panel



Blanco  
White

Crema  
Cream

Gris  
Grey

Chocolate  
Chocolate

Negro  
Black

Olive \*  
Olive

### Lona/ Canvas

**Panel lona tensa motorizada** / Motorized canvas panel

**Panel cortina manual** / Manual curtain panel

#### Soltis 96



Blanco  
96-8102  
White  
96-8102



Beige  
96-50843  
Beige  
96-50843



Gris  
96-2171  
Grey  
96-2171



Antracita  
96-2047  
Anthracite  
96-2047

#### Air



Piedra  
Stone



Negro  
Black



Blanco  
White



Arena  
Sand

### Madera/ Wood

**Panel media celosía madera vertical** / Half lattice wood vertical panel

**Panel completo celosía madera vertical** / Full lattice wood vertical panel



Iroko  
Iroko



Aluminio/Aluminium

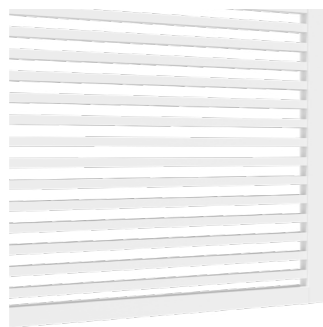

**Panel completo celosía aluminio horizontal**  
Full lattice aluminium horizontal panel

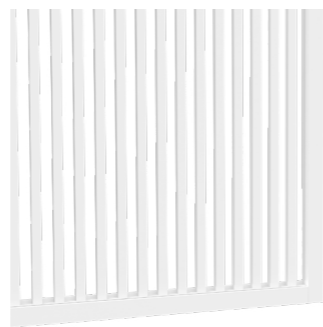

**Panel completo celosía aluminio vertical**  
Full lattice aluminium vertical panel

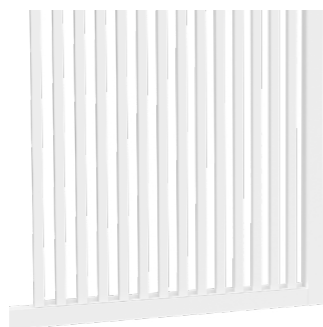

**Panel media celosía aluminio vertical**  
Half lattice aluminium vertical panel

Madera/Wood



**Panel completo celosía madera vertical**  
Full lattice wood vertical panel



**Panel media celosía madera vertical**  
Half lattice wood vertical panel

Lona/Canvas



**Panel cortina manual**  
Manual curtain panel



**Panel lona tensa motorizada**  
Motorized canvas panel

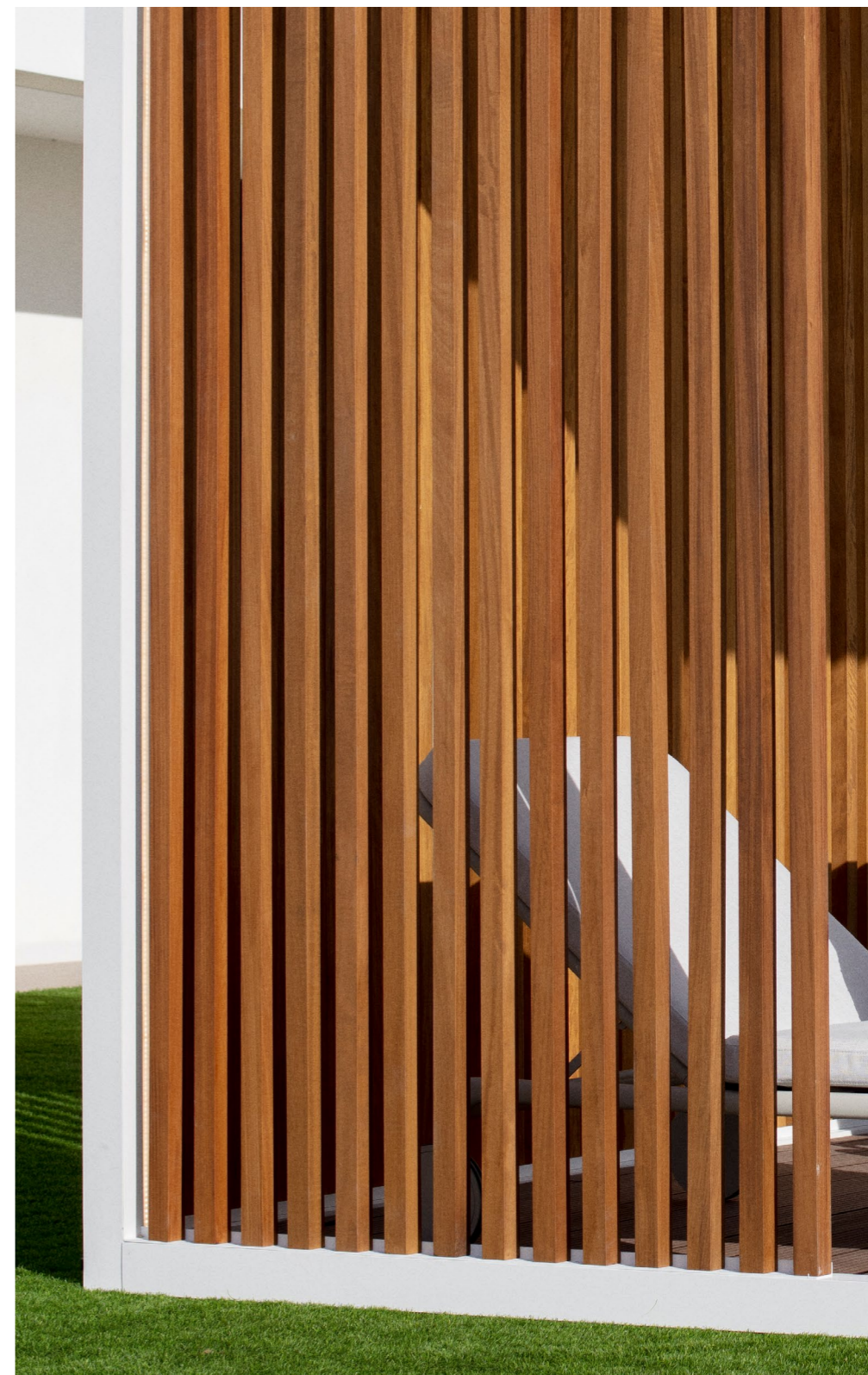



# BREZ

Bandada Studio

SUELOS/FLOOR



## Suelo técnico composite madera / Technical composite floor



Suelo técnico composite madera  
Technical composite floor

## Suelo cerámico C3 / Ceramic floor C3

Dekton \*

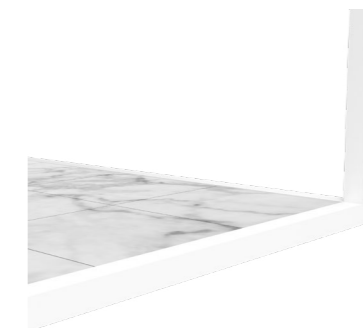
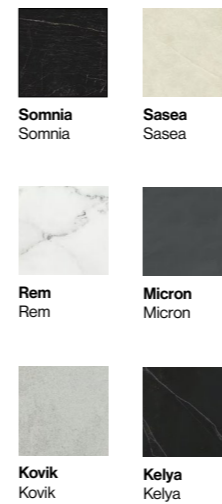

Suelo cerámico C3  
Ceramic floor C3

(\*) Colores disponibles a partir de abril 2023  
(\* Colours available from April 2023)



# COLECCIÓN COLORES

COLORS COLLECTION

(\*) Colores, tejidos y tableros disponibles a partir de abril 2023  
 (\*) Colours, fabrics and boards available from April 2023

## ALUMINIO / ALUMINIUM



**Blanco** White  
**Crema** Cream  
**Gris** Grey  
**Chocolate** Chocolate  
**Bronce** Bronze  
**Negro** Black  
**Navy** Navy



**Oro** Gold  
**Salmón** Salmon  
**Pardo\*** Brown  
**Olive\*** Olive  
**Violeta\*** Violet  
**Sky\*** Sky  
**Honey\*** Honey

## POLIPROPILENO / POLYPROPYLENE



**Blanco** White  
**Crema** Cream  
**Negro** Black  
**Pardo\*** Brown  
**Olive\*** Olive

## POLIETILENO / POLYETHYLENE



**Blanco** White  
**Crema** Cream  
**Chocolate** Chocolate  
**Negro** Black

## POLIETILENO LACADO / LACQUERED POLYETHYLENE



**Blanco** White  
**Crema** Cream  
**Chocolate** Chocolate  
**Negro** Black

## TABLEROS TABLETOP

(\*) Colores, tejidos y tableros disponibles a partir de abril 2023  
 (\*) Colours, fabrics and boards available from April 2023

### HPL 10 mm



**Blanco** White  
**Blanco (borde negro)** White (black edge)



**Crema** Cream  
**Negro** Black

### HPL 12 mm



**Marmól blanco\*** White marble  
**Marmól negro\*** Black marble  
**Corten\*** Corten

### DEKTON / DEKTON\*

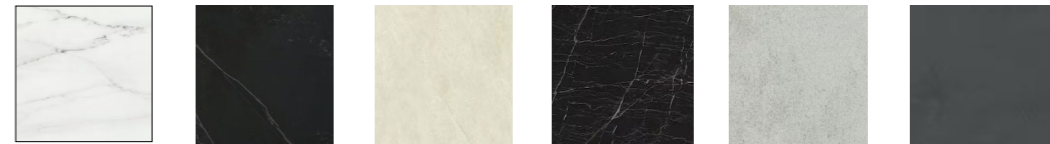

**Rem** Rem  
**Kelya** Kelya  
**Sasea** Sasea  
**Somnia** Somnia  
**Kovik** Kovik  
**Micron** Micron

## VIDRIO / GLASS



**Blanco** White  
**Crema** Cream  
**Negro** Black  
**Transparente** Transparent

## REPOSABRAZOS ARMREST

## MADERA / WOOD



**Iroko** Iroko

## TELAS DE CINTA TAPE FABRICS

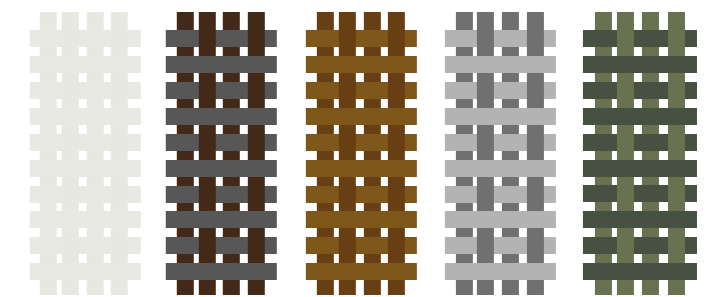

**vainilla**  
**chocolate antracita**  
**marrón toffee**  
**mármol basalto**  
**musgo\* tirol**



TELAS DE COLCHONETA Y COJÍN  
MAT & CUSHION FABRICS

(\*) Colores, tejidos disponibles a partir de abril 2023  
(\* Colours, fabrics and boards available from April 2023)

VITA \*

57%PP 38%PES 5%PU



blanco  
IMP07



Peso Weight	390 gr/m <sup>2</sup> ± 5% 546 gr/ml ± 5%	Resistencia al agua Columna de agua Waterproofing Water column	>2000mbar
Resistencia a la abrasión Abrasion resistance	EN ISO 12947-2:1998 60000	Tratamiento antibacteriano Antibacterial treatment	Yes
Solidez a la intemperie artificial Colour fastness to artificial weathering	EN ISO 105-B04:1997 (1000 horas) >6		

DOLCE

57%PP 38%PES 5%PU



ecrue  
IMP16

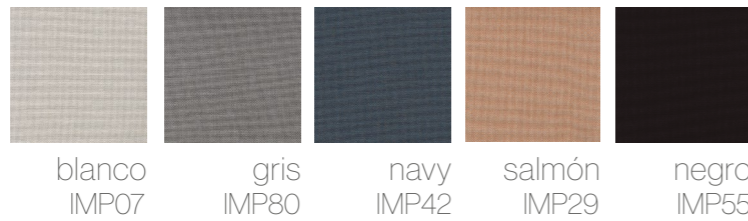

Peso Weight	390 gr/m <sup>2</sup> ± 5% 546 gr/ml ± 5%	Resistencia al agua Columna de agua Waterproofing Water column	>2000mbar
Resistencia a la abrasión Abrasion resistance	ISO 12947-2:1998 60000	Tratamiento antibacteriano Antibacterial treatment	Yes
Solidez a la intemperie artificial Colour fastness to artificial weathering	ISO 105-B04:1997 (1000 horas) >6		

BRUMA \*

100% Acrilico 100% Acrylic  
Water repellent. Anti-stain treatmnet

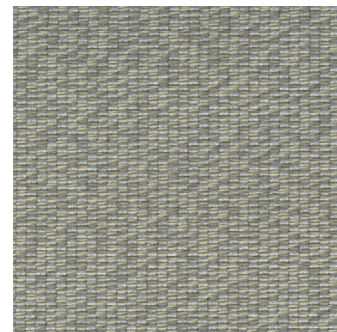

dragon  
1008

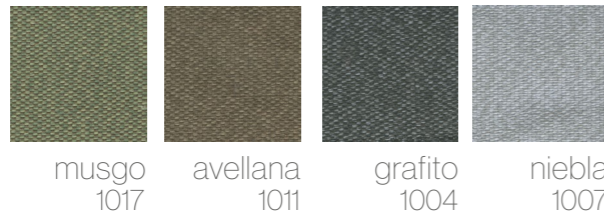

Peso Weight	400 gr/m <sup>2</sup>	Solidez a la luz Fastness to light	7/8
Resistencia a la abrasión Abrasion resistance	ISO 12497-2:2016 25000	Resistencia al agua Columna de agua Waterproofing Water column	ISO 20811 70mm
Solidez a la intemperie artificial Colour fastness to artificial weathering	ISO 105-B04:1998 4/5	Tratamiento antibacteriano Antibacterial treatment	Yes

PANAMA

100% Acrilico 100% Acrylic  
Water repellent. Anti-stain treatmnet



coco  
8001



Peso Weight	280 gr/m <sup>2</sup>	Solidez a la luz Fastness to light	7/8
Resistencia a la abrasión Abrasion resistance	ISO 12497-2:2016 2000	Resistencia al agua Columna de agua Waterproofing Water column	ISO 20811 100mm
Solidez a la intemperie artificial Colour fastness to artificial weathering	ISO 105-B04:1998 4/5	Tratamiento antibacteriano Antibacterial treatment	Yes

ASGARD \*

100% Acrilico 100% Acrylic

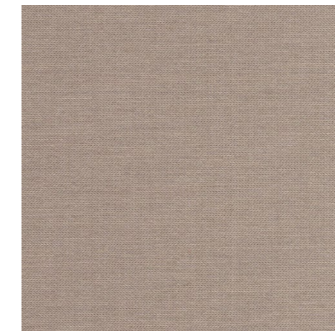

mud  
A44

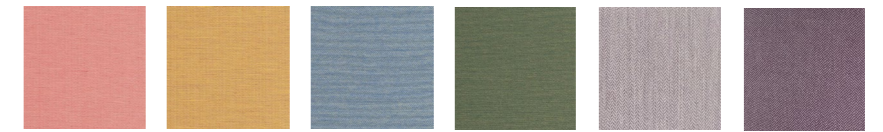

Peso Weight	330 gr/m <sup>2</sup>	Solidez a la luz Fastness to light	7/8
Resistencia a la abrasión Abrasion resistance	ISO 12497-2:2016 25000	Resistencia al agua Columna de agua Waterproofing Water column	ISO 20811 70mm
Solidez a la intemperie artificial Colour fastness to artificial weathering	ISO 105-B04:1998 7/8	Tratamiento antibacteriano Antibacterial treatment	Yes



# TALES \*

100% Acrílico 100% Acrylic

(\*) Colores, tejidos disponibles a partir de abril 2023  
 (\*) Colours, fabrics and boards available from April 2023

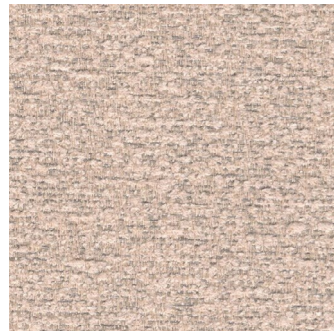

beige smoke  
1186



beige  
1180



grey black  
1188



meadow  
1182



milk brown  
1421

<b>Peso</b> Weight	460 gr/m2	<b>Solidez a la luz</b> Fastness to light	7/8
<b>Resistencia a la abrasión</b> Abrasion resistance	ISO 12497-2:2016 25000	<b>Resistencia al agua</b> Columna de agua Waterproofing Water column	ISO 20811 70mm
<b>Solidez a la intemperie artificial</b> Colour fastness to artificial weathering	ISO 105-B04:1998 7/8	<b>Tratamiento antibacteriano</b> Antibacterial treatment	Yes

## TELAS DE PROTECCIÓN SOLAR SOLAR PROTECTION

### SOLTIS 96

100% Poliester 100% Polyester

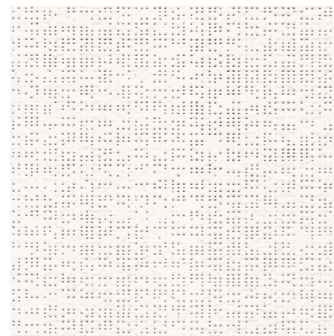

blanco  
96-8102

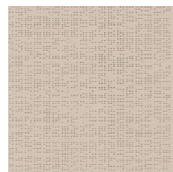

beige  
96-50843

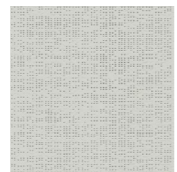

gris claro  
96-2171

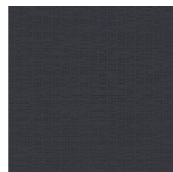

antracita  
96-2047

<b>Peso</b> Weight	400 gr/m2	<b>Resistencia al desgarro</b> Tear growth resistance	45/20 daN DIN 53.363
<b>Resistencia a la tracción</b> Tensile strenght	310/210 daN/5cm ISO 1421	<b>Solidez a la luz</b> Fastness to light	ISO 105 B02 7

### AIR \*

70% Acrílico 30%PES  
Softened



piedra



negro

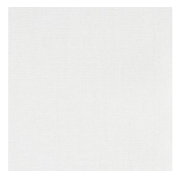

blanco



arena

<b>Peso</b> Weight	148 gr/m2	<b>Solidez a la luz</b> Fastness to light	7/8
<b>Solidez a la intemperie artificial</b> Colour fastness to artificial weathering	ISO 105-B04:1998 4/5		



Partida de las Tiesas 493  
 03400 Villena (Alicante) SPAIN  
 Tel. +34 966507356  
 info@mowee.com  
[www.mowee.com](http://www.mowee.com)







