

POTOCCO
ITALY

outdoor

POTOCO
ITALY



Since
1919

01.

Family is our starting point

Creatività italiana, tradizione artigianale e vocazione internazionale sono i tratti distintivi di Potocco, azienda a conduzione familiare, fondata nel 1919 da Domenico Potocco a Manzano (UD).

Potocco is a family-run company founded in 1919 by Domenico Potocco in Manzano (Udine). Italian creativity, artisan traditions and an international vocation are its distinctive traits.

Da piccola bottega artigiana per la produzione di sedie, Potocco si è evoluta nel corso degli anni trasformandosi in una vera e propria realtà industriale, specializzata nella creazione di arredi per la casa e il contract, adatti sia agli ambienti indoor che outdoor. Tappa fondamentale per l'azienda, la partecipazione nel 1961 al primo Salone del Mobile in qualità di socio fondatore.

Oggi guidata da Antonino Potocco, coadiuvato nel suo ruolo dalle figlie Alice e Marianna, quinta generazione della famiglia, l'azienda è presente in tutto il mondo grazie a una solida e vasta rete di distributori e alla recente apertura delle divisioni Potocco USA e Potocco Asia-Pacific.

From a small artisan workshop for the production of chairs, Potocco has evolved over the years, transforming into a large industrial reality, specialised in the creation of home and contract furnishing, for both indoor and outdoor environments. The milestone in the company's history is the participation at the first Salone del Mobile trade fair as a founding partner in 1961.

The Company is run by Antonino Potocco, assisted in his role by his daughters Alice and Marianna, the fifth generation of the family. The company is present throughout the world thanks to a solid and vast network of distributors and the recent opening of the Potocco USA and Potocco Asia-Pacific divisions.

004



005



Tailored industry
Bespoke



Leggera struttura in tubolare d'acciaio con intreccio in fettuccia nautica.
Light steel tubular structure with weaving in nautical ribbon.

Uncompromising quality
Home and Contract

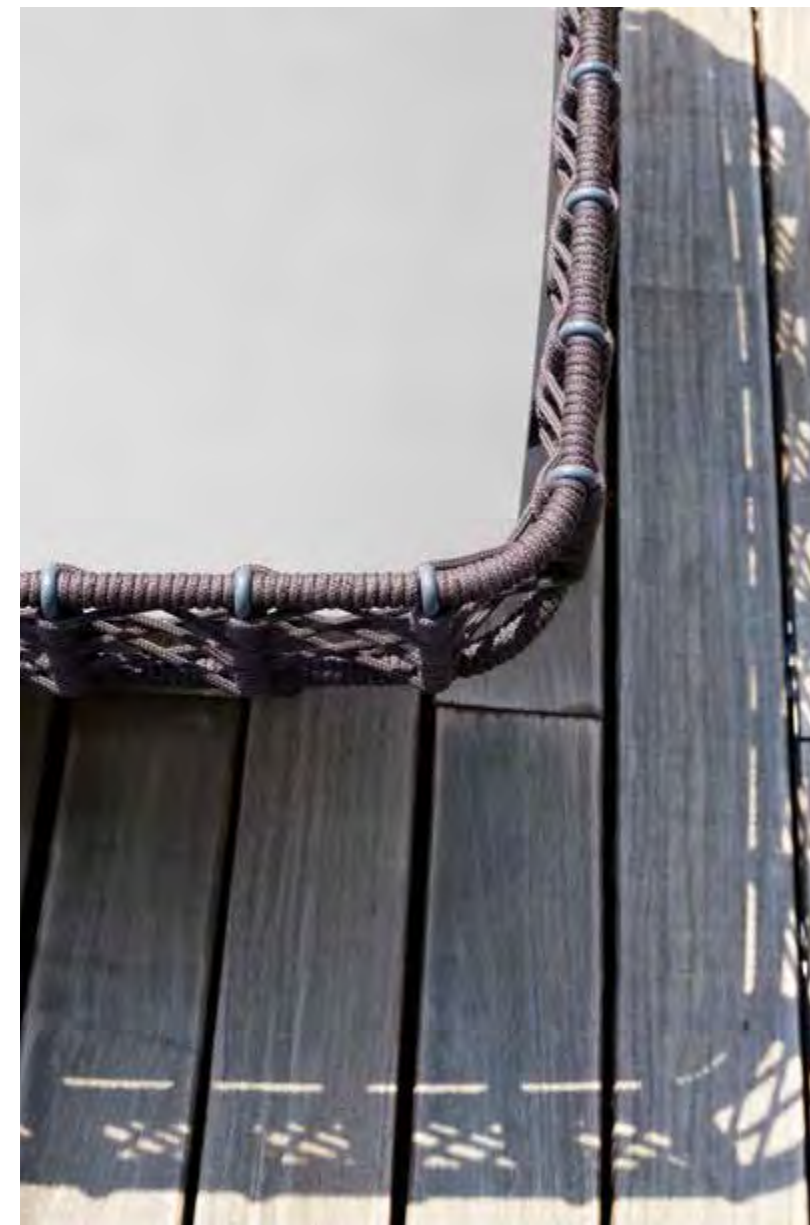

Top in grès porcellanato incorniciato da un bordo intrecciato a mano in cordino nautico.
Laminated porcelain top framed in hand woven nautical rope edge.

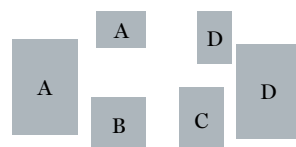
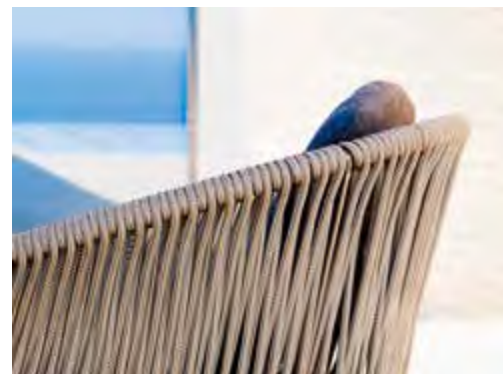

A.
Legno massello di Iroko e
texture in cordino gassa: un
perfetto equilibrio materico.
*Iroko wood and "Gassa"
rope texture: a perfect
material equilibrium.*

B.
Intreccio decorativo in cordino
nautico per struttura in tondino
di metallo cromato.
*Decorative nautical rope
weaving and chromed steel
tubular structure.*

C.
Sottili tubolari in metallo legati
assieme da intreccio in cordino
nautico.
*Thin steel tubes tied together
with nautical rope weaving.*

D.
La tecnica dell'intreccio a mano:
tra leggerezza e materia.
*Hand weaving technique: from
lightness to substance.*



010

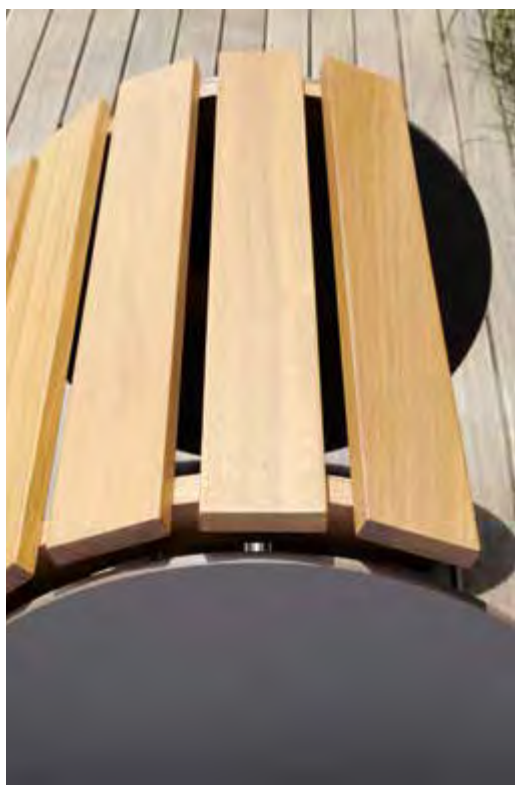

A.
Lavorazione del legno Iroko, espressione di un know-how artigianale.
Iroko wood processing, expression of an artisanal know-how.

B.
Praticità e comfort: doghe in legno Iroko e grandi ruote in HPL.
Comfort and functionality: Iroko wood slats and big HPL wheels.

C.
Metallo verniciato, braccioli intrecciati a mano e morbida imbottitura.
Painted metal, hand weaved armrests and soft upholstery.

D.
Legno, metallo, tessuto: tre materiali per una sola proposta.
Wood, metal, fabric: three materials for one proposal.

011





012



Selected references

Restaurant, cafés, lounge

AUSTRALIA <p>Nick's Bondi Beach (Sidney) Port Phillip Estate Winery (Melbourne) Star City Casino (Sidney)</p>	HOLLAND <p>Calaboose Rotterdam (Rotterdam) Bernardus Golf Club (Cromvoirt)</p>	SPAIN <p>Central Café (Barcelona)</p>
AUSTRIA <p>Casinò (Linz/Velden/Bregenz) Travel Charme Hotel (Hirschegg) Restaurant Goldader (Tamsweg) Café Radatz (Wien) Sky Bar (Graz)</p>	ITALY <p>Armani Café (Milan) Café Les Paillotes-De Cecco (Pescara)</p>	SWEDEN <p>Puntus By The Sea (Stockholm)</p>
BERMUDA <p>Mediterraneo Bar (Hamilton)</p>	JAPAN <p>Botanica Midtown (Tokyo) Rappongi Hills Club (Tokyo)</p>	SWITZERLAND <p>Villa Schweizer (Lucerne)</p>
FRANCE <p>Restaurant Le Passage (Lyon)</p>	PRINCIPALITY OF MONACO <p>Casinò (Monte Carlo) Forum Grimaldi (Monte Carlo)</p>	UNITED ARAB EMIRATES <p>Al Jawaher (Sharjah) The Seafood Restaurant, Aviation Club (Dubai)</p>
GERMANY <p>KDW (Berlin) Restaurant Fellini (Stuttgart) 20° Restobar (Düsseldorf)</p>	PORTUGAL <p>Vale Dos Pinheiros (Almancil)</p>	UNITED KINGDOM <p>Bibendum Oyster Bar (London) Conran's Restaurant (London) Coq d'Argent (London)</p>
GREECE <p>Salonico Restaurant (Salonico)</p>	QATAR <p>Oryx Lounge (Doha)</p>	USA <p>Aria De Cuba (New York) Blue Water Grill (Chicago) Planet Hollywood (New York) Bogey Hills Country Club (Atlanta)</p>
	RUSSIA <p>Tatler Club Moscow_Russia (Moscow) Torro Grill - Mercure (Kaliningrad) Mercur Crystal Palace (Kaliningrad)</p>	

Naval		
MSC <p>MSC Meraviglia MSC Seaside MSC Seaview MSC Bellissima</p>	GENTING HONG KONG <p>Crystal Debussy Crystal Ravel</p>	COSTA CROCIERE <p>Aida Diva Aida Luna Aida Bella Aida Vita Aida Aura Aida Blu Aida Stella Aida Sol Aida Mar</p>
NORWEGIAN CRUISE LINE <p>Norwegian Joy Norwegian Bliss</p>	ROYAL CARIBBEAN CRUISE LINES <p>Quantum Class Quantum Of The Seas Voyager Of The Seas Independence Of The Seas Mariner Of The Seas</p>	LEVANTE FERRIES <p>Ferryboat: Fior di Levante</p>
TUI CRUISES <p>Mein Schiff 1, 6</p> COMPAGNIE DU PONANT <p>M/V Austral M/V Le Ponant</p>		ATTICA FERRIES <p>Ferryboat: Superfast XI, XII Ferryboat: Blue Star Paros Ferryboat: Blue Star Naxos Ferryboat: Blue Star Ithaki</p>

Hotel		
AUSTRIA <p>Falkensteiner (Cristallo and Carinzia) Hilton Hotel (Vienna) Thermenhotel (Bad Ischl) Roemerbad Hotel (Bad Kleinkirchheim) Hotel Le Meridien (Wien) Hotel Andaz Vienna al Belvedere (Wien)</p>	ESTONIA <p>Palace hotel (Tallin)</p>	SWITZERLAND <p>Hotel Storchen (Zurich) Hotel Elnzerhorn Spa & Wellness (Lenzerheide) Hotel Grindelwald (Suhr)</p>
AZERBAIJAN <p>Intourist Hotel Baku (Baku)</p>	HUNGARY <p>Marriott (Budapest)</p>	THAILAND <p>Four Season (Bangkok)</p>
BELGIUM <p>Hotel Radisson Blu (Antwerp)</p>	ITALY <p>Hotel Gallia (Milan) Porto Piccolo Luxury Resort (Sistiana) Hotel Du Lac et Bellevue (Bardolino) Hotel Sportsman (Bardolino) Hotel Schwarzenstein (Luttach)</p>	UKRAINE <p>Holiday Inn (Kiev)</p>
CANADA <p>The W Hotel (Montreal)</p>	MALDIVES <p>Cheval Blanc Resort (Randheli)</p>	UNITED ARAB EMIRATES <p>Hotel New Archaic (Dubai) Kingdom Hotel Investment (Dubai)</p>
CHINA <p>Hotel Four Season (Shenzhen)</p>	QATAR <p>Al shamal Hotel Five Star Family Resort (Al Ruwais)</p>	UNITED KINGDOM <p>Shangri-La Hotel At The Shard (London) Hilton Hotel (Leeds) Hyatt Regency Hotel (Birmingham) Plaza Hotel Hyde Park (London)</p>
DENMARK <p>Scandinavia Hotel (Copenhagen)</p>	SAUDI ARABIA <p>Riyadh Hotel (Riyadh) Emirates Park tower hotel (Dubai)</p>	USA <p>Ritz Carlton (Chicago) Sheraton Fisherman's Wharf (San Leandro) Isla Bella Beach Resort (Marathon) Intercontinental SF Hotel (San Francisco) Renaissance DC Lobby Hotel (Washington DC) Hard Rock Hotel (Atlantic City) Embassy Suites by Hilton San Juan Hotel Puerto Rico (Puerto Rico) San Mateo Marriott (San Mateo) Restaurant Atelier Des Hoteles (Mexico) Disney Animal Kingdom Lodge Walt Disney (Orlando)</p>
FRANCE <p>La Coquillade Hotel (Garbas) Hotel Mandarin Oriental (Paris) Hotel Hilton (Evian) Hotel Hyatt (Paris) Hotel de Paris (Saint Tropez)</p>	SINGAPORE <p>Hotel Pan Pacif (Singapore)</p>	SLOVENIA <p>Intercontinental Lubiana (Lubiana)</p>
GERMANY <p>Hotel Le Meridien (Hamburg) Dorint Hotel (Germany) Hotel Rivoli (Munich) Ritz Carlton (Berlin)</p>	SPAIN <p>Kempinski Hotel Baia (Marbella)</p>	
GREECE <p>Hotel Grande Bretagne (Athens) Ledra Marriott Hotel (Athens)</p>	SOUTH KOREA <p>Hotel Conrad (Seoul) The W Hotel (Seoul)</p>	

Corporate		
AUSTRALIA <p>Victoria Racing Club (Melbourne) Department of Education (Paramatta)</p>	ITALY <p>Virgin Fitness Center</p>	UNITED ARAB EMIRATES <p>Pavillion at the park (Dubai)</p>
AUSTRIA <p>Volksbank (Salzburg) Martini Beleuchtungen (Vienna)</p>	JAPAN <p>Tokyo Airport (Tokyo) Tokyo University (Tokyo)</p>	UNITED KINGDOM <p>Morgan Stanley (London) Swiss Re Life & Health (London) Estée Lauder (London) Rolls Royce (London) Barclays Bank (London) Royal National Lifeboat Inc. (Poole) United Designer (Pearl)</p>
CHINA <p>CNC (Hangzhou)</p>	PRINCIPALITY OF MONACO <p>Red Bull Energy Drink</p>	USA <p>Smithsonian Institute (Washington) Swiss Embassy (Washington)</p>
FRANCE <p>Foncier Construction</p>	SWEDEN <p>World Of Golf (Gothenburg)</p>	
GERMANY <p>Golf Club Bad Nauheim (Sceaux) Mannesmann AG (Konigswinter)</p>	SWITZERLAND <p>Credit Suisse (Zurich) Banque Pictet (Geneva) Kurhotel & Privatklinik Oberwaid (St. Gallen) Bad Ragaz Golfclub (Bad Ragaz) Zurich assicurazioni (Zurich) Kusnacht Klinik (Kusnacht)</p>	

POTOCO
ITALY

In-
dex

- 01. SINCE 1919**
 - Since 1919 \ 003
 - Selected references \ 014

- 02. ABACO**
 - Catalogue overview \ 021

- 03. PRODUCT COLLECTIONS**
 - Agra \ 092
 - Aria \ 116
 - Butler \ 156
 - Dock \ 104
 - Egao \ 110
 - Elodie \ 086
 - Herm \ 142
 - Hishi \ 066
 - June \ 062
 - Katana \ 122
 - Keel \ 100
 - Land \ 152
 - Little T \ 138
 - Loom \ 070
 - Ola \ 030
 - OTX \ 038
 - Purple \ 080
 - Ropu \ 128
 - Suno \ 146
 - Vela \ 052
 - Velis \ 048
 - Weld \ 134

- 04. TECHNICAL SHEETS**
 - Drawings \ 161

- 05. FINISHES**
 - Materials & Coverings \ 173

Aba-
co

02.

Sedie & poltrone | *Chairs & armchairs*



Agra
688/XXL
collection 092
technical sheet 162



Agra
688/PXXL
collection 092
technical sheet 162



Aria
864
collection 116
technical sheet 162



Aria
864/P
collection 116
technical sheet 162



Egao
037
collection 110
technical sheet 164



Egao
037/P
collection 110
technical sheet 164



Egao
037/PBR
collection 110
technical sheet 164



Keel
922
collection 100
technical sheet 166



Keel
922/P
collection 100
technical sheet 166



Ola
923
collection 030
technical sheet 168
others 042/047
105/126-127

Sgabelli | *Stools*



Agra
688/S
collection 092
technical sheet 162



Agra
688/A
collection 092
technical sheet 162



Aria
864/S
collection 116
technical sheet 162



Aria
864/A
collection 116
technical sheet 162



Egao
037/A
collection 110
technical sheet 164



Vela
698/S
collection 052
technical sheet 170



Vela
698/A
collection 052
technical sheet 170

Tavoli | *Tables*



Ola
923/P
collection 030
technical sheet 168
others 047/105/126-127



Vela
698
collection 052
technical sheet 170
others 039



Vela
698/P
collection 052
technical sheet 170
others 039/123



Velis
942/PAR
collection 048
technical sheet 171
others 043/108-109



Dock
897/TR FIX
collection 104
technical sheet 163
others 093/102-103



Dock
897/TR
collection 104
technical sheet 163
others 102-103/108-109



Katana
026/TC3
collection 122
technical sheet 165
others 031



Katana
026/TR4
collection 122
technical sheet 165
others 051/111



OTX
887/TC
collection 038
technical sheet 168
others 113



OTX
887/TQ
collection 038
technical sheet 168

Pouf & poggiapiedi | *Poufs & footrests*



OTX
887/TSC
collection 038
technical sheet 168
others 053



OTX
887/TSQ
collection 038
technical sheet 168



OTX
887/TAC
collection 038
technical sheet 168



Agra
688/PP
collection 092
technical sheet 162



Herm
925/O45-OUT
collection 142
technical sheet 164



Herm
925/O60-OUT
collection 142
technical sheet 164
others 060-061/154-155



Herm
925/O80-OUT
collection 142
technical sheet 164



Ropu
888/CQR-OUT
collection 128
technical sheet 170
others 074-075/078-079
084-085/090-091



OTX
887/TAQ
collection 038
technical sheet 168
others 117



OTX
887/TGC
collection 038
technical sheet 168
others 036-037
049/120-121

Tavolini | *Coffee tables*



Hishi
871/TBC
collection 066
technical sheet 165
others 065/074-075/087



Hishi
871/TBQ
collection 066
technical sheet 165
others 074-075/081
084-085/087



Little T
878/TQ-50
collection 138
technical sheet 166
others 060-061/071
090-091



Little T
878/TQ-100
collection 138
technical sheet 166



Little T
878/TR
collection 138
technical sheet 166
others 060-061
090-091/159



Agra
688/LP
collection 092
technical sheet 162



June
921/PL
collection 062
technical sheet 165
others 102-103/129



Loom
880/PR-OUT
collection 070
technical sheet 167
others 067/069



Purple
935/P-OUT
collection 080
technical sheet 169
others 113/135



Ropu
888/TBC
collection 128
technical sheet 170
others 074-075/078-079
081/084-085



Ropu
888/TBR
collection 128
technical sheet 170
others 074-075/078-079/081
084-085/087/145/150-151



Weld
865/TCB
collection 134
technical sheet 171
others 063



Weld
865/TCH
collection 134
technical sheet 171



Vela
698/LP
collection 052
technical sheet 170
others 137

Divani | Sofas



Elodie
908/D-OUT
collection 086
technical sheet 164
others 132-133/139/141



Loom
880/DR-OUT — 880/DR-200-OUT
collection 070
technical sheet 167



Loom
880DRL+880/DRM
collection 070
technical sheet 167
others 150-151



Purple
935/D-OUT
collection 080
technical sheet 169



Vela
698/D
collection 052
technical sheet 170

Daybed & Lettini | Daybeds & Sunbeds



Agra
688/D-RECL
collection 092
technical sheet 162



Loom
880/DB-OUT
collection 070
technical sheet 167



Land
896/D-RECL
collection 152
technical sheet 166



Purple
935/CL-OUT
collection 080
technical sheet 169



Suno
895/D-RECL
collection 146
technical sheet 170
others 065/102-103

Accessori | Accessories



Butler
892
collection 156
technical sheet 163
others 056-057/090-091
108-109/126-127

Product
Collections

03.

DESIGN
RADICE & ORLANDINI

sedia | chair
poltrona | armchair

Ola

La famiglia di sedute Ola, composta da sedia impilabile e poltroncina, si caratterizza per la forma dello schienale avvolgente, in tondino di metallo, che ricorda l'immagine fluida dell'onda: intrecciato a mano in fettuccia "Fly" si piega nelle tre dimensioni per accogliere il corpo umano e garantire un perfetto comfort. La struttura è in tubo di metallo abbinata ad un morbido cuscino di seduta imbottito.

The Ola seating family, composed by armchair and stackable chair, is characterized by a wrapping backrest, in tubular metal, which recalls the fluid waves' image: hand weaved in "Fly" ribbon, it bends in three dimensions to wrap the human body guaranteeing the perfect comfort. The structure is in embossed metal tube with soft seating cushion padded in polyurethane foam.





OLA / 923 / 923/P
 sedia | chair / poltrona | armchair





036

037

OLA sedia | chair / poltrona | armchair - OTX tavolo | table

DESIGN
GABRIELE E OSCAR BURATTI

tavoli | tables

OTX

Versatili e dal design essenziale i tavoli OTX con gamba centrale e quattro piedini, sono caratterizzati da un piano reclinabile verticalmente in HPL, tondo o quadrato in tre dimensioni differenti, per poterli accostare uno accanto all'altro. Estremamente funzionali, sono inoltre proposti in tre altezze per diversi utilizzi: da spazi collettivi a bar, da giardini a terrazze. È inoltre proposto nella versione dining Ø128 e Ø158cm, con base in metallo verniciata e piano sempre in HPL.

Versatile and with an essential design, the OTX tables with a central leg and four feet are characterized by a vertically reclining top in HPL, round or square in 3 different sizes, that makes them placeable side by side. Extremely functional, they are also offered in three heights for different uses from collective spaces to bars, from gardens to terraces. It is also proposed in the dining version, Ø128 and Ø158cm, with a painted metal base and HPL top.



OTX tavolo | table - VELA sedia | chair / poltrona | armchair

OTX

887/TQ
tavolo | table



OTX

887/TSQ
tavolo | table



040

OTX

887/TC
tavolo | table



OTX

887/TSC
tavolo | table



041



042

OTX tavolo | table - OLA sedia | chair



043

OTX tavolo | table - VELIS poltrona pozzetto | tub chair

OTX

887/TAQ
tavolo | table



044





OTX / 887/TGC
tavolo | table



OTX tavolo | table - OLA sedia | chair / poltrona | armchair

DESIGN
MARIO FERRARINI

poltrona pozzetto | tub chair

Velis

Declinata nella versione poltroncina per utilizzo outdoor, con cuscino schienale incluso, Velis si presta a qualsiasi ambiente sottolineando ancora una volta la maestria artigianale dell'azienda nell'adattare i prodotti ad ogni esigenza. Velis ha una struttura in legno massello di Iroko e schienale con struttura in metallo verniciato intrecciato in cordino "Gassa" o corda nautica canapa, seduta imbottita in poliuretano espanso e rivestita con finiture e rivestimenti per outdoor a collezione.

Declined in the armchair version for outdoor use, with included back cushion, Velis is suitable for all environments, emphasizing once again the craftsmanship of the company in adapting the products to every occasion. Velis has a structure in solid Iroko wood and a back with a painted metal frame woven with "Gassa" cord or hemp nautical rope, a seat upholstered in fire retardant polyurethane foam and covered with outdoor finishes as per collection.



VELIS poltrona pozzetto | tub chair - OTX tavolo | table



VELIS 942/PAR
poltrona pozzetto | tub chair



VELIS poltrona pozzetto | tub chair - KATANA tavolo | table

DESIGN
HANNES WETTSTEIN

sedia | chair
poltrona | armchair
lounges | lounge armchair
divano | sofa
sgabelli | stools

Vela

La famiglia Vela, composta da sedia, poltroncina, poltrona lounge, impilabili, sgabelli e divano è la perfetta sintesi tra design e maestria artigianale: all'agile struttura in tubo di metallo con gambe a slitta è abbinato un intreccio realizzato a mano in cordino nautico o PVC che ne costituisce l'elemento di unicità.

The Vela family, composed by stackable chair, armchair, lounge chair and stools and sofa is the perfect synthesis between design and craftsmanship: the slender frame in metal tube with sled-shaped legs is matched with hand-woven nautical or PVC rope, making it unique.

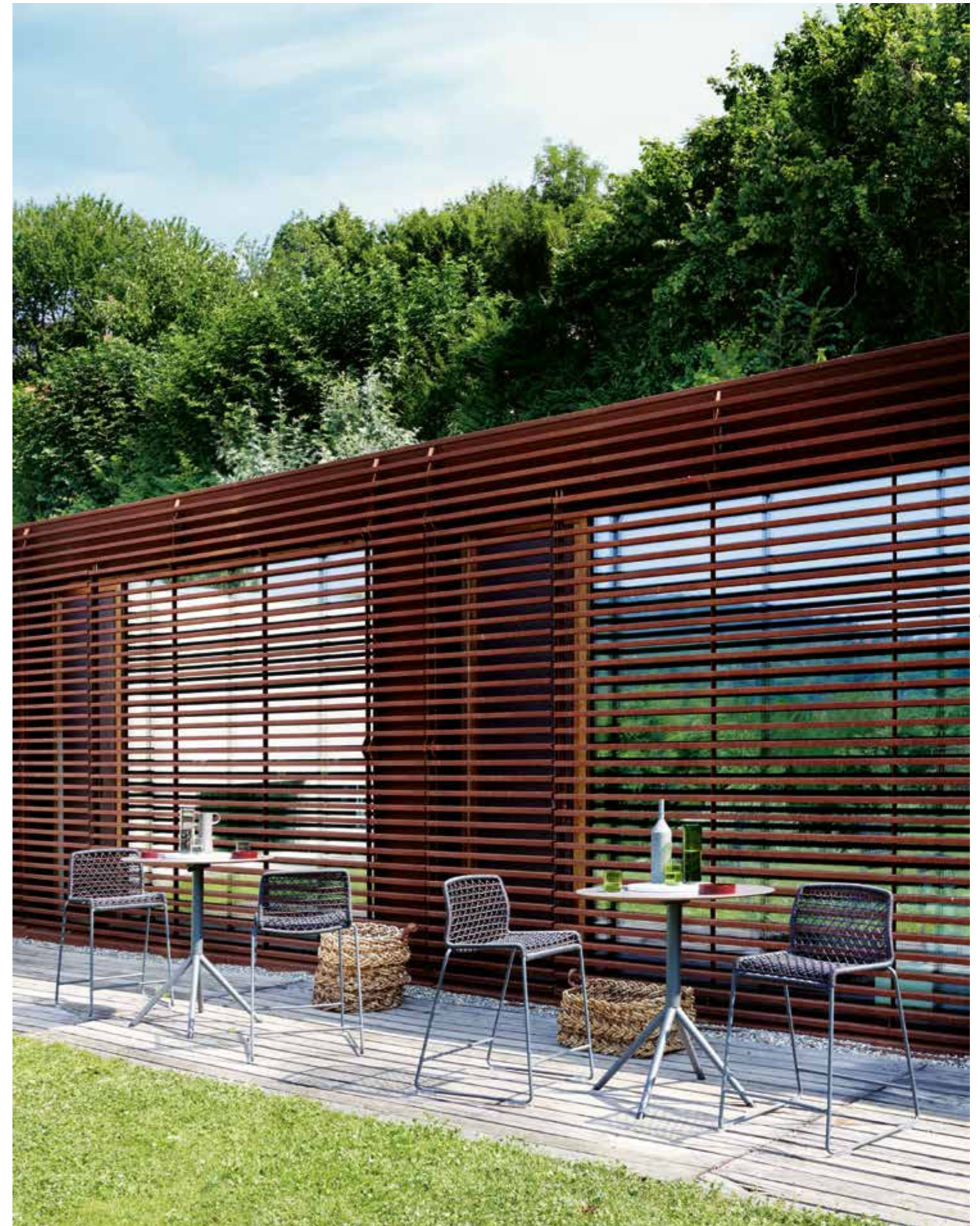

VELA

698/A
sgabello alto | barstool



VELA

698
sedia | chair



054

055

VELA

698/P
poltrona | armchair



VELA

698/S
sgabello basso | counterstool





VELA sedia | chair / poltrona | armchair - DOCK tavolo | table - BUTLER carrello | trolley - OTX tavolo | table - VELIS poltrona pozzetto | tub chair

VELA

698/PL

lounge | lounge armchair



058

VELA

698/D

divano | sofa



059



VELA lounge | lounge armchair / divano | sofa - LITTLE T tavolini | coffee tables - HERM pouf | pouf

DESIGN
BERNHARDT & VELLA

lounge | lounge armchair

June

June è una poltrona lounge con struttura in tubo di metallo verniciato avvolta, in corrispondenza dei braccioli e della seduta, da un intreccio in cordino nautico o "Gassa" che ne disegna la linea, divenendone elemento estetico e funzionale. L'indipendenza fra la struttura e i cuscini di seduta e schienale, esprime la logica del razionalismo alla quale l'intero progetto si ispira.

June is a lounge armchair with painted metal tube structure hand-waved, on the armrests and at the seat correspondence, in nautical or "Gassa" rope, which defines its lines, becoming its aesthetic and functional element. The independence between the structure and the seat and back cushions conveys the rationalism from which the project gets inspiration.



JUNE lounge | lounge armchair - WELD tavolino | coffee table



JUNE / 921/PL
lounge | lounge armchair

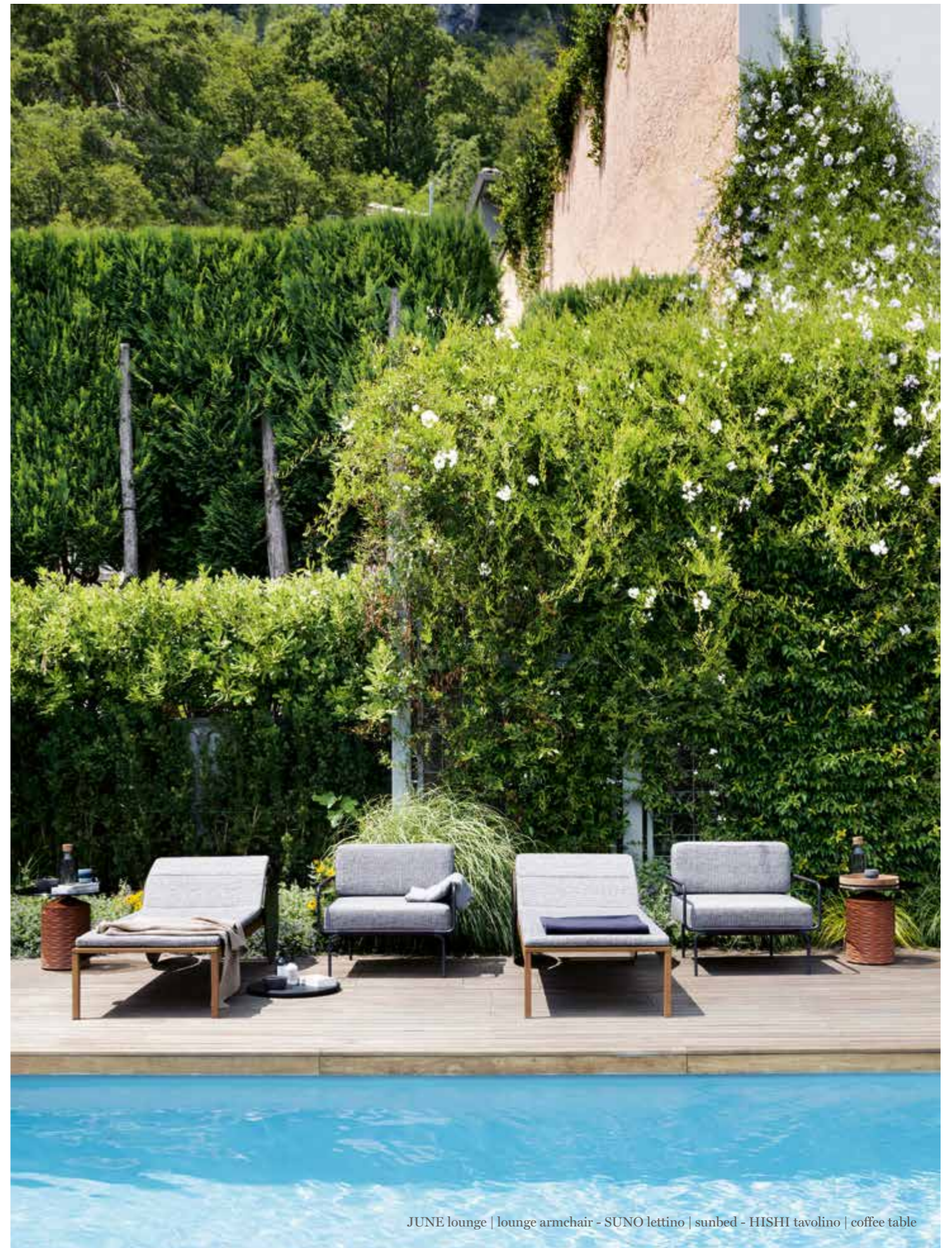

JUNE lounge | lounge armchair - SUNO lettino | sunbed - HISHI tavolino | coffee table

DESIGN
CHIARA ANDREATTI

tavolini | coffee tables

Hishi

La base in ceramica smaltata grigio sabbia e pesca, caratterizzata da un decoro a bassorilievo a maglia geometrica realizzato artigianalmente, che attraverso il deposito della cristallina crea ricercati effetti cromatici, contraddistingue la famiglia di tavolini Hishi. Proposti nelle due altezze, 47 cm e 55 cm, sono disponibili con piano tondo o quadrato in vetro bronzato.

The base in sand gray and peach ceramic, characterized by a hand-crafted geometric-patterned bas-relief decoration, which through the deposit of the crystalline creates refined chromatic effects, distinguishes the Hishi coffee tables' family. Available in two heights, 47 cm and 55 cm, they are available with round or square top in bronzed glass.



HISHI tavolini | coffee tables - LOOM lounge | lounge armchair



HISHI

871/TBC
tavolino | coffee table

871/TBQ
tavolino | coffee table



DESIGN
DAVID LOPEZ QUINCOCES

lounge | lounge armchair
divani | sofas
divano modulare | modular sofa
daybed | daybed

Loom

Ispirazione retró per la collezione Loom composta da divano, poltrona e daybed. Minimalismo e semplicità definiscono il progetto: a disegnarne il profilo, un'essenziale cornice in mogano con intreccio a mano in cordino "Gassa" o sintetico, eco di una tradizione artigianale ed espressione di una profonda abilità manuale.

A retró inspiration for the Loom collection, consisting in sofas, armchair and daybed. Minimalism and simplicity define its design: to outline its profile, a mahogany frame with "Gassa" or synthetic rope weaving insert, echo of a craft tradition and expression of a deep manual ability.

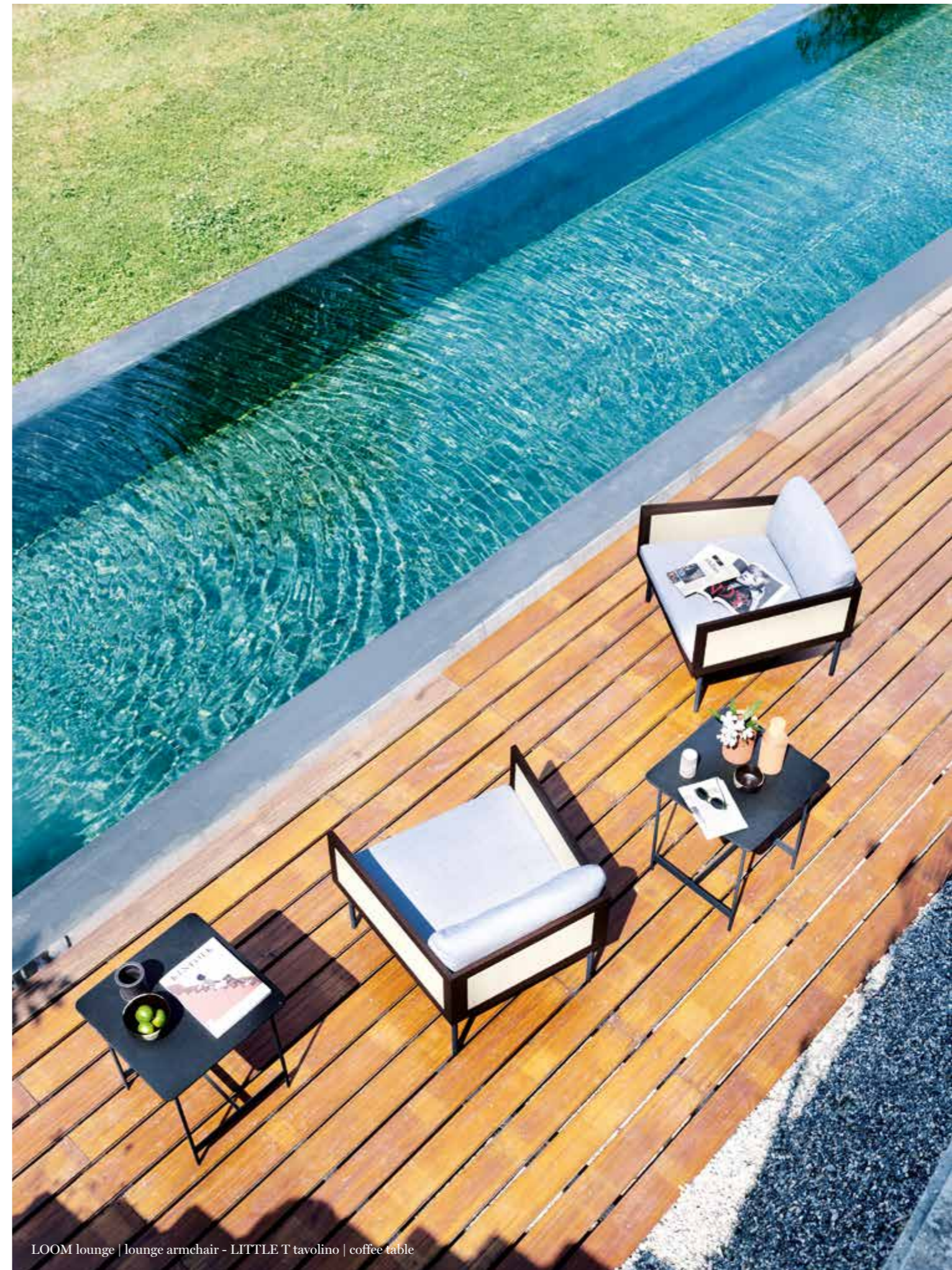

LOOM lounge | lounge armchair - LITTLE T tavolino | coffee table

LOOM

880/PR-OUT
lounge | lounge armchair



LOOM

880/DRL, DRM
divano modulare | modular sofa



LOOM

880/DB-OUT
daybed | daybed





LOOM daybed | daybed / divano | sofa / lounge | lounge armchair - HISHI tavolini | coffee tables - ROPU tavolini | coffee tables / pouf | pouf
OLA poltrona | armchair - DOCK tavolo | table

LOOM

880/DR-OUT
divano | sofa



076



LOOM

880/DR-200-OUT
divano | sofa



077



DESIGN
STUDIO MARCO VIOLA

divano modulare | modular sofa
lounge | lounge armchair
daybed | daybed

Purple

La famiglia di imbottiti Purple, composta da divano modulare, poltrona e daybed, si contraddistingue per la soffice e avvolgente cuscineria sfoderabile in tessuto, che funge da schienale e seduta per il massimo comfort. Profili irregolari donano a Purple un aspetto fresco, rendendolo adatto ad un utilizzo outdoor sia per la casa che per il contract.

The Purple family of upholstered modular sofas, armchair and daybed, is characterized by the soft and curved cushioning with removable fabric covers, serving as back and seat for the maximum comfort. Its irregular profiles give Purple a fresh look, making it suitable for an outdoor use, both for domestic and contract ambiances.



PURPLE divano | sofa - HISHI tavolino | coffee table - ROPU tavolini | coffee tables

PURPLE

935/P-OUT
lounges | lounge armchair



PURPLE

935/D-OUT
divano modulare | modular sofa



082

PURPLE

935/CL-OUT
daybed | daybed



083

PURPLE

935/D-OUT
divano modulare | modular sofa





084

085

PURPLE lounge | lounge armchair / divano | sofa - HISHI tavolini | coffee tables - ROPU tavolini | coffee tables / pouf | pouf

DESIGN
CHIARA ANDREATTI

divano | sofa

Elodie

Il divano a due posti Elodie è caratterizzato da una struttura essenziale a vista, in tubo di metallo verniciato antracite goffrato, bianco e avall, pensato per accogliere gli ampi cuscini a cui è appoggiata una piastra in metallo che corre tutto intorno alla cuscinatura, sorreggendola. Dettaglio distintivo il cuscino di seduta che, grazie a dei particolari sostegni, si distacca dalla struttura risultando sospeso. I piedini, posizionati lungo il profilo esterno, amplificano la sensazione che i cuscini galleggino all'interno della gabbia metallica.

The Elodie two-seater sofa features a visible and essential structure in anthracite, white or avall embossed painted metal tube, designed to accommodate the large cushions, on which a metal plate leans running all around supporting them. A peculiarity of the project is the seat's cushions which, thanks to special supports, are detached from the structure, appearing suspended. Its feet, positioned alongside its external profile, amplify the floating sensation of the cushions.





ELODIE

908/D-OUT
divano | sofa



ELODIE divano | sofa - LITTLE T tavolini | coffee tables - ROPU pouf | pouf - BUTLER carrello | trolley

DESIGN
ENRICO FRANZOLINI

sedia | chair
poltrona | armchair
lounge | lounge armchair
poggiapiedi | footrest
sgabelli | stools
lettino | sunbed

Agra

Agra è una collezione che si identifica per i tratti raffinati e rigorosi, declinata in sedie e poltroncine impilabili, lounge, poggiapiedi, sgabelli e lettino: arredi capaci di creare ambienti dal gusto sempre nuovo grazie ad un'ampia varietà di materiali e finiture. Tratto distintivo di questa famiglia è l'intreccio a mano che conferisce alle proposte a collezione un impatto visivo di estrema leggerezza, che si adatta perfettamente a fresche atmosfere mediterranee.

Agra is a collection identified by refined and rigorous lines, declined in stackable chairs and armchairs, lounge, footrest, stools and sunbed: products capable of creating always fresh and new ambiences thanks to the wide variety of materials and finishes. A distinctive trait of this family is the hand weaving that gives to the collection's proposals a visual impact of extreme lightness, adapting perfectly these products to fresh Mediterranean atmospheres.



AGRA

688/S
sgabello basso | counterstool

688/A
sgabello alto | barstool

094



AGRA

688/XXL
sedia | chair

688/PXXL
poltrona | armchair

095





096

097



AGRA / 688/LP lounge | lounge armchair / 688/PP poggiapiedi | footrest



AGRA / 688/D-RECL lettino | sunbed

DESIGN
M+V

sedia | chair
poltrona | armchair

Keel

La famiglia Keel composta da sedia e poltroncina, nasce da una ricerca sul tema del rapporto tra rigore geometrico e sinuosità organica. Keel, nome che richiama il mondo della nautica, rappresenta il tentativo di trovare il miglior equilibrio tra una struttura lineare in tondino di metallo ed elementi d'appoggio in legno Iroko dalle forme morbide e sinuose che presentano una lavorazione molto particolare e curata.

The Keel seating family is composed by a chair and an armchair. The name Keel, recalls the nautical world and represents the will to find equilibrium between the linear metal tube structure and the support elements in Iroko wood. Slender and sinuous lines, define the particular and cured processing.



KEEL

922/P
poltrona | armchair

922
sedia | chair



KEEL sedia | chair / poltrona | armchair - DOCK tavolo | table - JUNE lounge | lounge armchair - HISHI tavolino | coffee table - SUNO lettino | sunbed

DESIGN
DAVID LOPEZ QUINCOCES

tavoli | tables

Dock

Il tavolo Dock si contraddistingue per l'allure di leggerezza: struttura e piano sono elegantemente asciutti, ridotti al minimo spessore. Le doghe in legno Iroko sono disposte una accanto all'altra, a comporre un'armonica e ordinata sequenza, mentre su entrambi i lati la sezione del piano si rastrema lievemente ai bordi, donando al tavolo un aspetto aereo. È disponibile in una versione fissa da 200 cm e in una con piano estensibile.

The Dock table is characterized by a light structure: legs and top are smartly dry, shortened in their width. The slats, in Iroko wood, are disposed close to one another, composing an harmonic and organized sequence, while on both sides, the section of the top is tapered at the edges, giving the table an airy aspect. It is available in the fixed 200 cm version and in the one with extendable top.



DOCK tavolo | table - OLA sedia | chair / poltrona | armchair

DOCK

897/TR FIX
tavolo | table



106

DOCK

897/TR
tavolo estensibile | extendable table





DESIGN
TOAN NGUYEN

sedia | chair
poltrone | armchairs
sgabello | stool

Egao

Famiglia di sedute composta da sedia e poltroncina impilabili e sgabello, Egao presenta una snella struttura in metallo rivestita di un intreccio in cordino sintetico o in corda nautica, con il quale crea una trama quadrettata che funge da seduta e schienale. Una famiglia di prodotti passepartout adatta ad ogni tipo di collocazione, sia domestica che contract.

A seating collection composed by a stackable chair and armchair, and a stool, Egao presents a slender metal structure covered by a hand weaved rope that creates a squared texture, set out to serve as seat and back of the chair. The collection is suitable for all kind of positioning, both in-house and contract.



EGAO sedia | chair / poltrona | armchair - KATANA tavolo | table



EGAO sgabello | stool

EGAO sedia | chair / poltrona | armchair / sgabello | stool - OTX tavolo | table
PURPLE divano | sofa / lounge | lounge - ROPU pouf | pouf



114

EGAO / 037/P
poltrona | armchair

037
sedia | chair

037/PBR
poltrona | armchair



115

EGAO / 037/A
sgabello | stool

DESIGN
ENRICO FRANZOLINI

sedia | chair
poltrona | armchair
sgabelli | stools

Aria

L'intreccio in fettuccia nautica è l'elemento distintivo che lega tutte le sedute della famiglia Aria, creando un rivestimento dalla trama accattivante intorno alla struttura in acciaio, nelle varianti verniciato e acciaio inox. Disponibile nelle versioni sedia e poltroncina impilabili e sgabello, Aria sceglie materiali leggeri e resistenti che la rendono adatta ad integrarsi in tutti gli ambienti outdoor.

The weaving in nautical ribbon is the distinctive element that links all the seatings of the Aria family, creating a coating with a captivating weave around the steel structure in the painted and inox versions. Available in stackable chair and armchair versions as well as stool version, Aria chooses light and resistant materials that makes it suitable for all outdoor environments.



ARIA / 864/P
poltrona | armchair

864
sedia | chair



ARIA / 864/S
sgabello basso | counterstool

864/A
sgabello alto | barstool





ARIA sedia | chair / poltrona | armchair - OTX tavolo | table

DESIGN
MAURO LIPPARINI

tavoli | tables

Katana

A decretare l'unicità del tavolo Katana è il peculiare disegno delle gambe in metallo, che richiama le antiche spade giapponesi a lama curva dalle quali il prodotto prende il nome. Proposta versatile, Katana è un tavolo pensato per adattarsi ai contesti all'aria aperta, proposto sia in una versione a tre gambe con piano tondo $\Phi 120$ e $\Phi 130$ cm, sia in una rettangolare a quattro gambe, entrambe con piano in grès porcellanato o HPL.

The uniqueness of the Katana table is underlined by the peculiar design of the metal legs that recalls the ancient curved blades of Japanese swords, from which the product gets its name. Katana is a versatile proposal, adaptable to open air contexts, available with round top $\Phi 120$ e $\Phi 130$ cm - with or without Lazy Susan - or rectangular top with four legs, in laminated porcelain or HPL.



KATANA

026/TR4
tavolo | table



KATANA

026/TC3
tavolo | table





KATANA tavolo | table - OLA sedia | chair / poltrona | armchair - BUTLER carrello | trolley

DESIGN
CHIARA ANDREATTI

tavolini | coffee tables
pouf | pouf

Ropu

Dalle rimembranze esotiche, Ropu si distingue per la bordatura intrecciata in cordino "Gassa", che corre lungo il perimetro creando una cornice per il top in grès porcellanato e HPL oppure soffici cuscini con profili a coda di topo. Con base a quattro gambe in metallo, la collezione è disponibile nella versione tavolino basso con piano rettangolare o alto con piano tondo e pouf rettangolare, da abbinare in libere composizioni.

From exotic remembrances, Ropu stands out for its sophisticated woven edge in "Gassa" rope. This runs along the perimeter structure creating a frame for laminated porcelain or HPL tops or soft cushions with mouse-tail cord profiles. With a four-legs metal base, the collection consists of a low coffee table with rectangular top or a high coffee table with round top and rectangular pouf, combinable in the desired compositions.





ROPU / 888/TBR / 888/TBC
 tavolino | coffee table / tavolino | coffee table



ROPU / 888/CQR-OUT
 pouf | pouf



DESIGN
BUSETTI, GARUTI E REDAELLI

tavolini | coffee tables

Weld

Weld è una famiglia di tavolini disponibili in due altezze e dimensioni composta da una base in metallo verniciato e dettagli in cordino nautico con piano tondo in HPL o Iroko.

La struttura dei tavolini è tanto semplice quanto distintiva: i tre sottili tubi di metallo delle gambe, impreziositi dal cordino intrecciato attorno ai punti di incontro tra esse, formano un'intersezione visiva che cambia quando l'osservatore sposta il punto di vista.

Weld is a family of coffee tables available in two different heights and dimensions, composed by a painted metal structure with hand waved details in nautical ribbon, and HPL or Iroko wood round top.

The coffee tables' structure is as simple as distinctive: the three thin metal tube legs, embellished by the hand waved rope around the meeting points between them, forms a visual intersection that changes with the point of view.



WELD tavolino | coffee table - PURPLE lounge | lounge armchair

WELD

865/TCB
tavolino | coffee table

865/TCH
tavolino | coffee table



WELD tavolino | coffee table - VELA lounge | lounge armchair

DESIGN
POTOCO D&D

tavolini | coffee tables

Little T

La rigorosa struttura in metallo gofrato anima il disegno dei tavolini Little T. Proposti in tre dimensioni e altezze diverse, i tavolini sono ideali come piano d'appoggio fianco e fronte divano o a creare differenti composizioni. Con piano in grès porcellanato sono pensati per l'utilizzo all'aria aperta, dagli ambiti domestici a quelli contract.

The rigorous embossed metal structure animates the design of the Little T coffee tables. Available in three different sizes and heights, these tables are ideal as a side or front sofa table, creating different compositions. With laminated porcelain top, they are designed for outdoor use, from domestic to contract ambiances.



LITTLE T tavolini | coffee tables - ELODIE divano | sofa



LITTLE T

878/TQ-50
tavolino | coffee table

878/TQ-100
tavolino | coffee table

878/TR
tavolino | coffee table



LITTLE T tavolini | coffee tables - ELODIE divano | sofa

DESIGN
GIANLUIGI LANDONI

pouf | poufs

Herm

Un dettaglio sartoriale contraddistingue il pouf Herm: una cintura in tessuto con cuciture a vista lo circonda creando raffinati plissé; dotata di una pratica maniglia, questa ne agevola lo spostamento. Proposto in tre diverse forme, Herm può essere utilizzato singolarmente o a creare differenti composizioni per personalizzare terrazze e giardini.

A tailored detail distinguishes the Herm pouf: a belt in fabric with visible stitchings that surrounds the pouf creating fine pleats. A handle is fitted to make it easier moving it around. Available in 3 different shapes, it comes in the outdoor version to give a personal touch to terraces and gardens.

HERM

925/O45-OUT
pouf | pouf

925/O80-OUT
pouf | pouf

925/O60-OUT
pouf | pouf





HERM pouf | poufs - ROPU tavolino | coffee table

DESIGN
JOHAN LINDSTÉN

lettino | sunbed

Suno

Suno reinterpreta la forma universale del lettino prendisole contraddistinguendosi per le grandi ruote dal diametro 57 cm, in HPL. Un'iperbole formale che fa di un elemento funzionale il tratto estetico che connota l'intero progetto. Con struttura composta da doghe in legno Iroko e corredata da un materasso imbottito, Suno presenta uno schienale regolabile in diverse inclinazioni per vivere il relax all'aria aperta all'insegna del massimo comfort.

Suno reinterprets the universal shape of the sunbed, distinguishing itself by the large HPL wheels with a 57 cm diameter. A hyperbole that makes of a functional element the aesthetic trait that characterizes the project. With a structure in Iroko wood slats, accompanied by a padded mattress, Suno's backrest is adjustable at different inclinations, giving the possibility to enjoy outdoor relaxation in the name of maximum comfort.

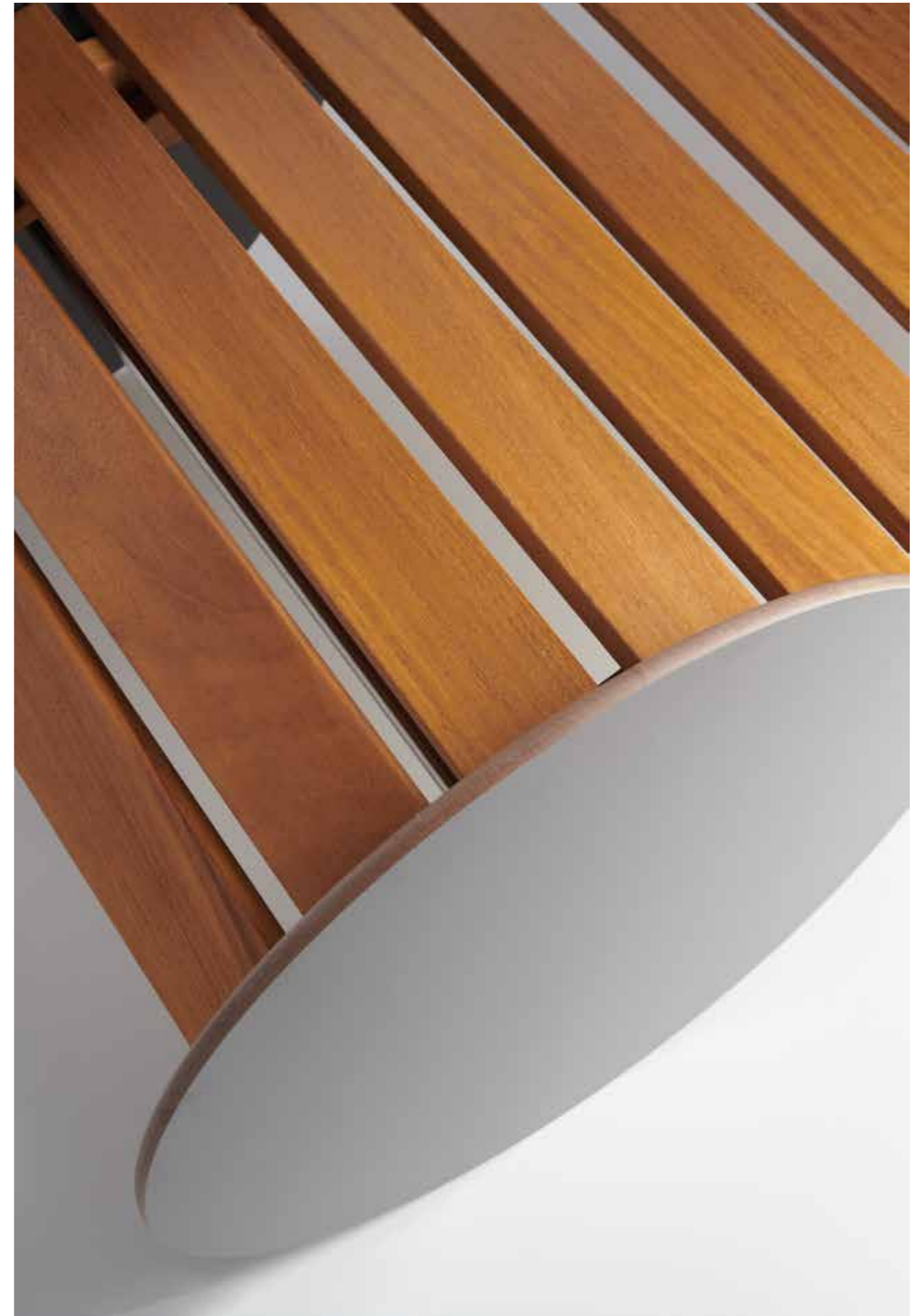

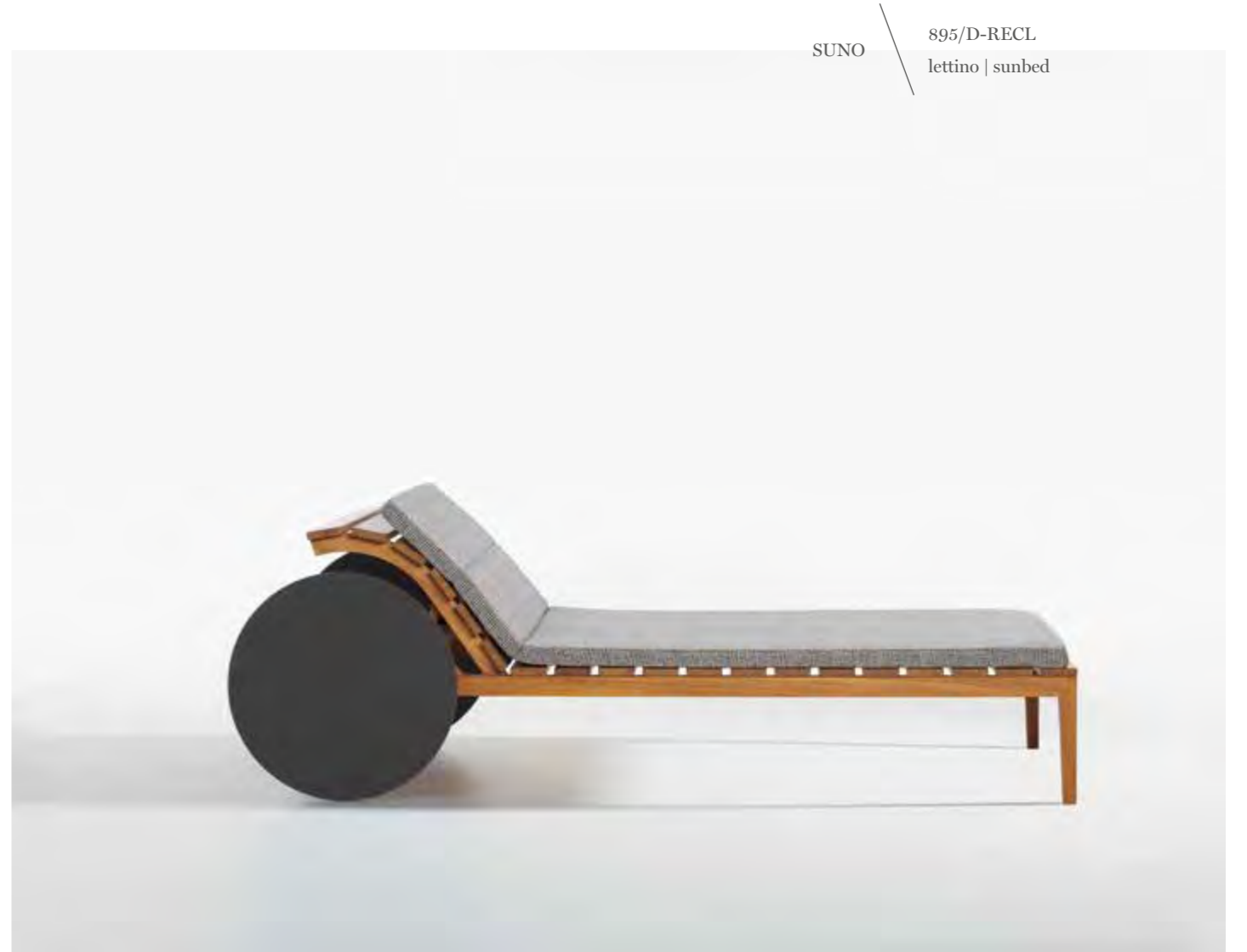

SUNO

895/D-RECL
lettino | sunbed



SUNO lettino | sunbed - ROPU tavolino | coffee table / pouf | pouf - BUTLER carrello | trolley - LOOM divano |sofa

DESIGN
POTOCO D&D

lettino | sunbed

Land

Land è un lettino da terra firmato dall'azienda Potocco: un prodotto capace di portare all'esterno l'idea di comfort declinata negli spazi interni. Grazie a una struttura in legno Iroko con schienale reclinabile corredato da un materassino imbottito e rivestito nei tessuti per esterni, Land sa rivolgersi sia al contesto domestico che al mondo contract, passando dall'hotelliere al mondo navale.

Land is a sunbed conceived by Potocco's D&D Department: a product capable of transporting outside the idea of indoor comfort. Thanks to its Iroko wood structure and mattress padded in polyurethane foam, covered with outdoor fabrics as per collection, Land is suited for domestic ambiances as well as contract, passing through the hotellerie and naval.



LAND

896/D-RECL
lettino | sunbed



LAND lettino | sunbed - HERM pouf | pouf - ELODIE divano | sofa - LITTLE T tavolini | coffee tables - OTX tavolo | table
 VELIS poltrone pozzetto | tub armchairs - ROPU pouf | pouf - BUTLER carrello | trolley

DESIGN
BERNHARDT & VELLA

carrello | trolley

Butler

Butler è un carrello portavivande da esterno, ideale per organizzare, trasportare e contenere anche cibo e stoviglie o altri oggetti. Il piano superiore in legno Iroko, insieme a quello inferiore e al contenitore portabottiglie in metallo, removibile secondo esigenza, creano un gioco di volumi e linee con la struttura.

Butler is an outdoor trolley, ideal to organize, transport and contain food, tableware and other objects. The superior top in Iroko wood together with the inferior level and the food-trolley container in metal, removable on necessity, create a game of volumes and lines with the structure.



BUTLER carrello | trolley

BUTLER

892
carrello | trolley



158



BUTLER carrello | trolley - ELODIE divano | sofa - LITTLE T tavolino | coffee table

Technical
Sheets

04.

COPERTURE OUTDOOR
OUTDOOR COVERINGS

Per tutti i nostri prodotti Outdoor sono disponibili coperture impermeabili per lo stoccaggio durante il periodo di non utilizzo. Per ulteriori specifiche e dettagli fare riferimento al listino prezzi.

For all our Outdoor products waterproof covers are available for stocking during the period of non-use. For further specifications and details refer to the price list.

AGRA

Design Enrico Franzolini
pag. 092

Collezione di sedute, lounge e lettino. Sedia e poltroncina impilabile e sgabelli con struttura in tubo di metallo. Disponibile con intrecci in cordino sintetico o in PVC. Lounge impilabile e poggiatesta con struttura in tubo di metallo. Disponibile con intrecci in cordino sintetico o in PVC. Lettino reclinabile con struttura in acciaio inox. Disponibile con intrecci in cordino PVC. Finiture e rivestimenti di collezione.

Collection of seats, lounge armchair and sunbed. Stackable chair and armchair, and stools with stainless steel frame. Available in synthetic or PVC rope weaving. Stackable lounge armchair and footrest with stainless steel frame. Available in synthetic or PVC rope weaving. Reclining sunbed with stainless steel frame. Available in PVC rope weaving. Materials as per collection.

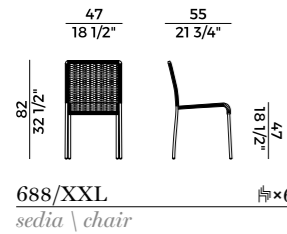

688/XXL sedia \ chair $\times 6$

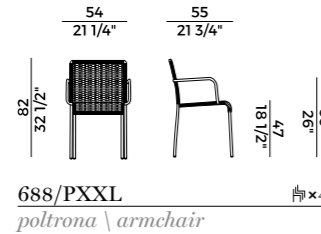

688/PXXL poltrona \ armchair $\times 4$

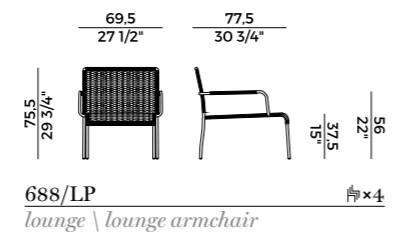

688/LP lounge \ lounge armchair $\times 4$

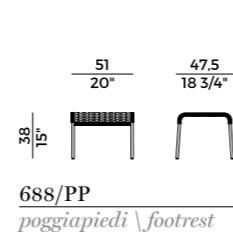

688/PP poggiatesta \ footrest

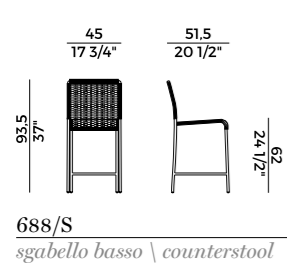

688/S sgabello basso \ counterstool

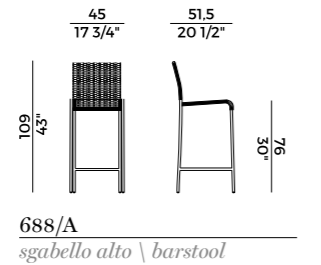

688/A sgabello alto \ barstool

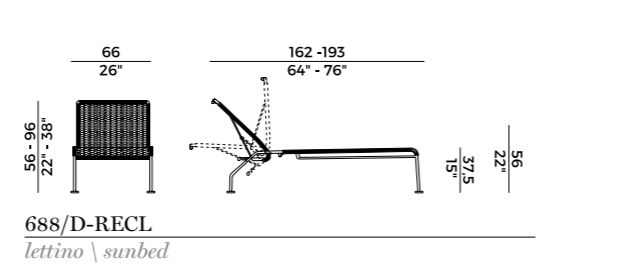

688/D-RECL lettino \ sunbed

ARIA

Design Enrico Franzolini
pag. 116

Sedia e poltroncina impilabili e sgabelli in due altezze differenti. Struttura in tubo di metallo. Disponibile con intrecci in fettuccia nautica. Finiture di collezione.

Stackable chair, small armchair and stools with two different heights. Frame in stainless steel. Available in nautical ribbon weaving. Materials as per collection.

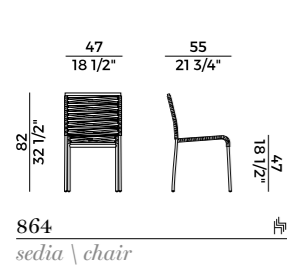

864 sedia \ chair $\times 6$

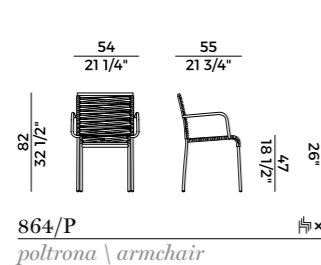

864/P poltrona \ armchair $\times 4$

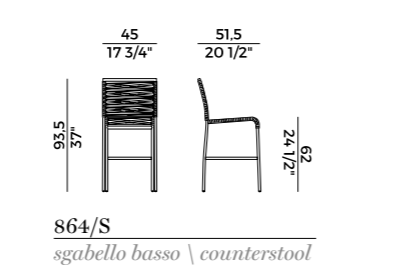

864/S sgabello basso \ counterstool

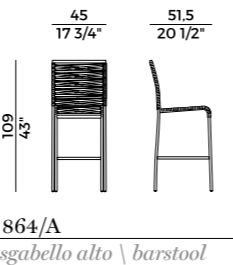

864/A sgabello alto \ barstool

BUTLER

Design Bernhardt & Vella
pag. 156

Carrello con struttura in metallo verniciato antracite gofrato e piano in legno massello di Iroko. Cassetto contenitore fisso e porta bottiglie laterale removibile in metallo verniciato.

Trolley with anthracite embossed lacquered metal frame and Iroko solid wood top. Fixed drawer and removable side bottle holder in painted metal.

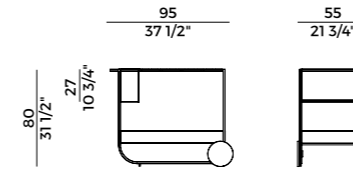

892 carrello \ trolley

DOCK

Design David Lopez Quincoecs
pag. 104

Tavolo rettangolare con struttura e top a doghe in legno massello di Iroko. Disponibile versione estensibile.

Rectangular table with Iroko solid wood slatted frame and top. Extendable version available.

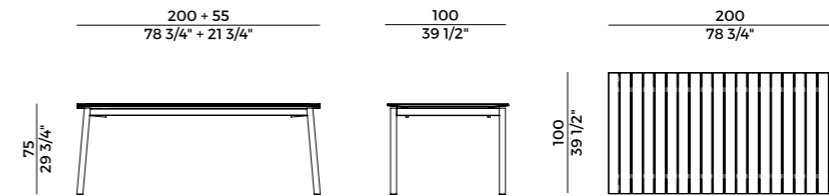

897/TR FIX tavolo \ table

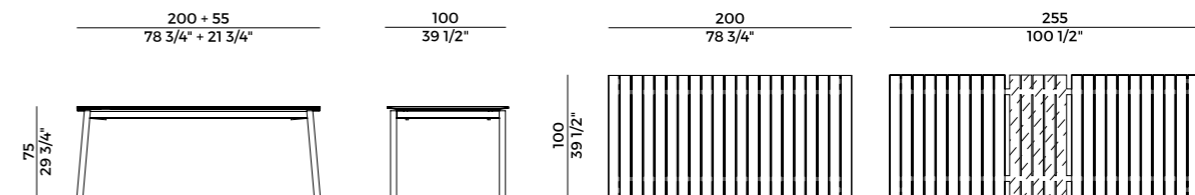

897/TR tavolo estensibile \ extendable table

EGAO

Design Toan Nguyen
 \ pag. 110

Sedia e poltroncina impilabili e sgabello. Struttura in tubo di metallo verniciato. Intrecci in cordino sintetico moka o in corda nautica. Poltroncina disponibile in due versioni: braccioli con o senza intreccio. Finiture di collezione.

Stackable chair, armchair and stool. Frame in stained metal tube. Woven in moka synthetic rope or nautical rope. Small armchair available in two versions: armrests with or without interweaving. Materials as per collection.

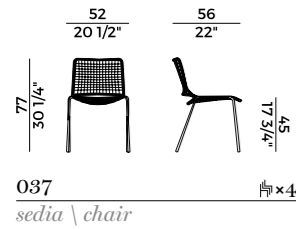

037
sedia \ chair

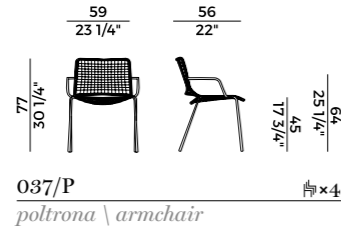

037/P
poltrona \ armchair

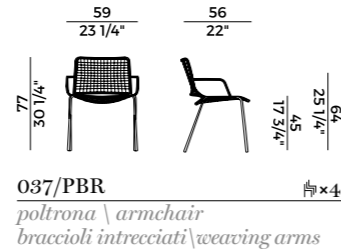

037/PBR
*poltrona \ armchair
 braccioli intrecciati \ weaving arms*

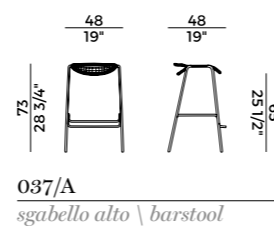

037/A
sgabello alto \ barstool

ELODIE

Design Chiara Andreatti
 \ pag. 086

Divano con struttura in tubo di metallo verniciato antracite, bianco o Aval. Cuscini dello schienale sfoderabili. Cuscini laterali su richiesta. Finiture e rivestimenti di collezione.

Sofa with structure in anthracite, white or Aval painted metal. Back cushions with removable covers. Side cushions on request. Materials and coverings as per collection.

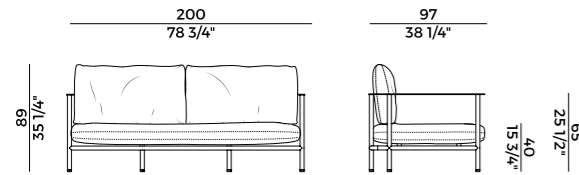

908/D-OUT
divano \ sofa

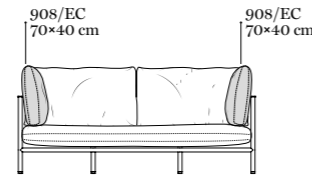

908/EC
cuscini laterali \ side cushions

HERM

Design Gianluigi Landoni
 \ pag. 142

Famiglia di pouf imbottiti in poliuretano espanso ignifugo. Disponibili in tre misure. Fascia e rivestimenti a collezione.

Family of upholstered poufs padded with fire retardant polyurethane foam. Available in three sizes. Belt and coverings as per collection.

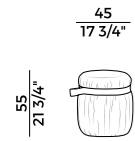

925/O45-OUT
pouf \ pouf

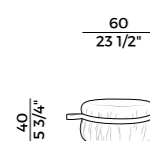

925/O60-OUT
pouf \ pouf

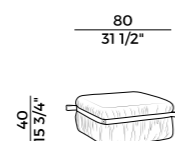

925/O80-OUT
pouf \ pouf

HISHI

Design Chiara Andreatti
 \ pag. 066

Collezione di tavolini in due altezze. Base in ceramica con finitura lucida color pesca o grigio sabbia. Top quadrato o tondo in vetro bronzato.

Collection of coffee tables with two different heights. Ceramic base with peach or grey sand finish. Square or circular top in bronzed glass.

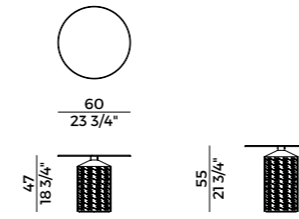

871/TBC
tavolino \ coffee table

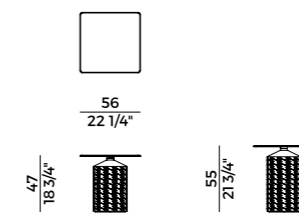

871/TBQ
tavolino \ coffee table

JUNE

Design Bernhardt & Vella
 \ pag. 062

Lounge con struttura in metallo verniciato. Cuscini di seduta e schienale imbottiti in poliuretano espanso. Braccioli rivestiti in corda nautica o in cordino "Gassa". Finiture e rivestimenti di collezione.

Lounge armchair with painted metal frame. Seat and backrest padded in polyurethane foam. Armrests woven in nautical or "Gassa" rope. Materials and coverings as per collection.

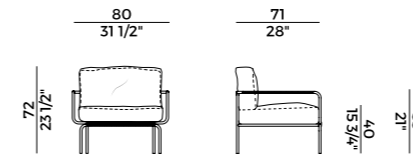

921/PL
lounge \ lounge armchair

KATANA

Design Mauro Lipparini
 \ pag. 122

Famiglia di tavoli con gambe in metallo verniciato. Tavolo tondo con tre gambe. Tavolo rettangolare con quattro gambe. Piano in HPL o grès porcellanato. Finiture di collezione.

Family of tables with legs in painted metal. Round table with three legs. Rectangular table with four legs. Top in HPL or laminated porcelain. Materials as per collection.

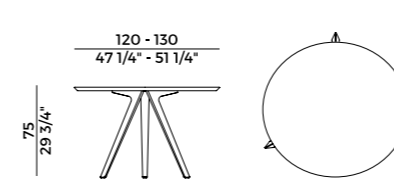

026/TC3
tavolo \ table

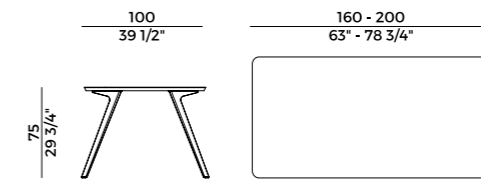

026/TR4
tavolo \ table

KEEL

Design M+V
 \ pag. 100

Sedia e poltroncina sfoderabili con struttura in tondino di metallo verniciato, schienale in massello di Iroko e seduta imbottita in poliuretano espanso. Finiture e rivestimenti di collezione.

Chair and armchair with removable cover, structure in embossed metal rod, backrest in Iroko and seat padded in polyurethane foam. Materials and coverings as per collection.

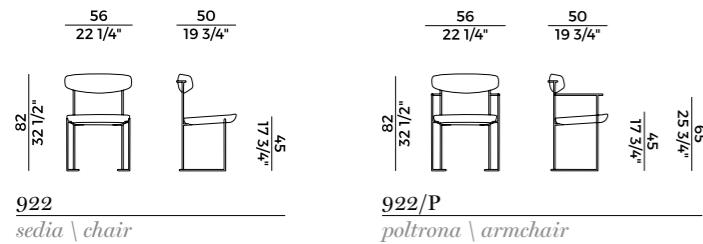

LAND

Design Potocco D&D
 \ pag. 152

Letto a terra in legno massello Iroko con schienale regolabile. Materasso imbottito in DryFeel. Rivestimenti di collezione.

Iroko solid wood sunbed with adjustable backrest. Mattress padded in DryFeel. Coverings as per collection.

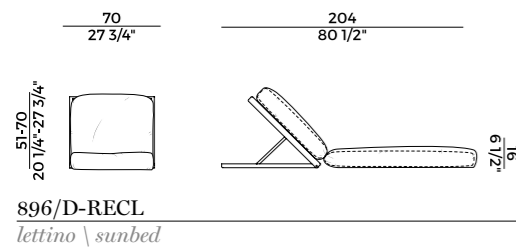

LITTLE T

Design Potocco D&D
 \ pag. 138

Famiglia di tavolini con struttura in metallo verniciato antracite goffrato e piano in grès porcellanato. Finiture di collezione.

Family of coffee tables with anthracite embossed lacquered metal frame and laminated porcelain top. Materials as per collection.

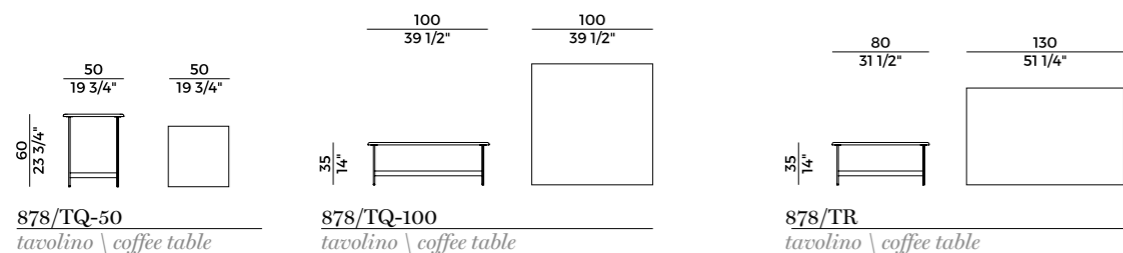

LOOM

Design David Lopez Quincoecs
 \ pag. 070

Collezione di divani, poltrona e daybed. Struttura in massello di mogano con inserti in cordino "Gassa" o cordino sintetico moka. Piedini in metallo verniciato antracite goffrato. Cuscineria interna in poliuretano espanso ignifugo. Cuscini laterali su richiesta. Finiture e rivestimenti di collezione.

Collection of sofas, armchair and daybed. Solid wood frame with "Gassa" rope or moka synthetic rope inserts. Feet in anthracite embossed lacquered metal. Cushions padded with fire retardant polyurethane foam. Side cushions on request. Materials and coverings as per collection.

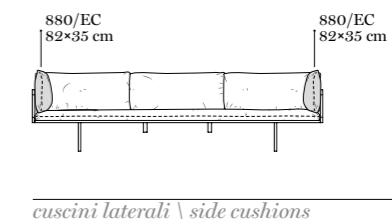
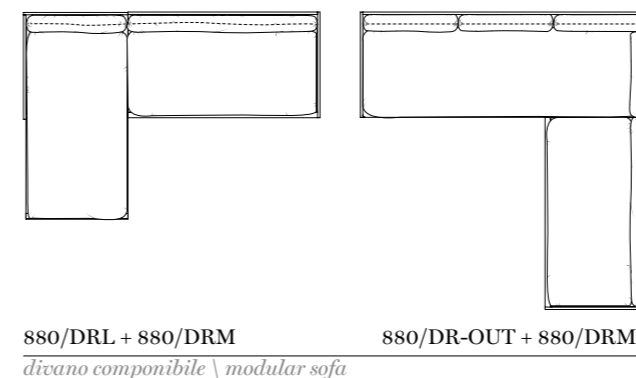
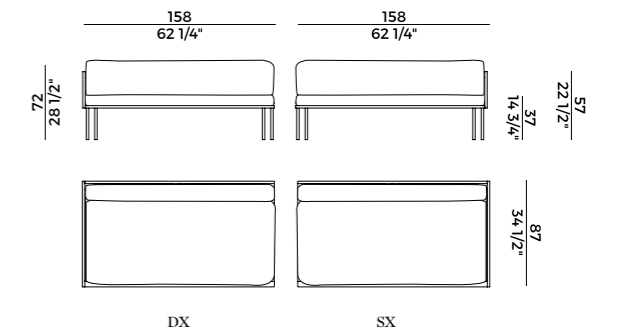
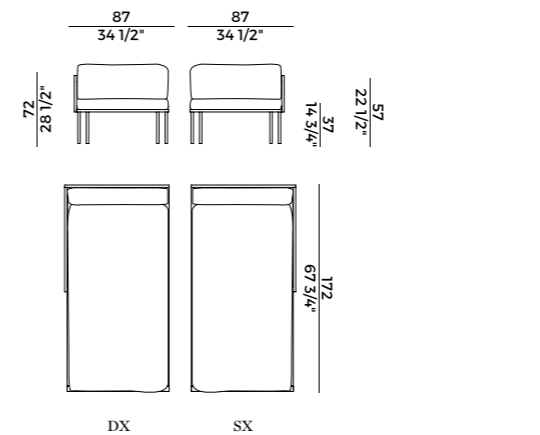
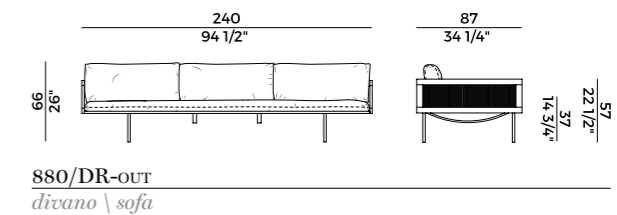
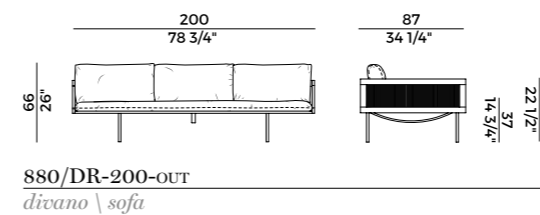
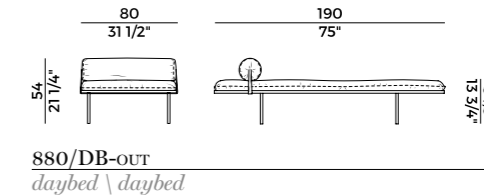
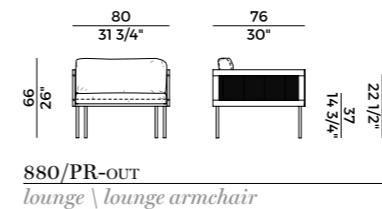

OLA

Design Radice & Orlandini
 \ pag. 030

Sedia e poltroncina con cuscino seduta incluso. Struttura in metallo verniciato intrecciata in fettuccia "Fly". Seduta imbottita in DryFeel. C'è la possibilità di impilare fino a 4 sedie con cuscino e fino a 6 senza cuscino. Finiture e rivestimenti di collezione.

Chair and armchair with seat cushion included. Embossed metal frame woven with "Fly" ribbon. Seat padded in DryFeel. Stackable chairs up to 4 with cushions and up to 6 without cushions. Materials and coverings as per collection.

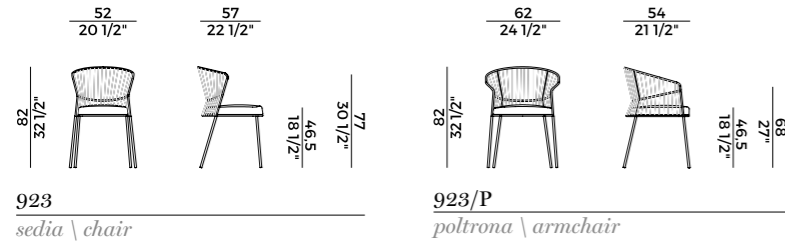

☰×4 con cuscino \ with cushion
 ☰×6 senza cuscino \ without cushion

OTX

Design Gabriele e Oscar Buratti
 \ pag. 038

Famiglia di tavoli disponibili nelle versioni:
 - tavoli con piano reclinabile, disponibili in tre altezze e tre dimensioni, con piano tondo o quadrato;
 - tavolo con piano circolare in due dimensioni;
 Base in metallo verniciato. Piano in HPL.

Set of tables available in the following versions:
 - tables with folding top, available in three heights and three sizes, with round or square top;
 - table with round top available in two sizes;
 Base in painted metal. Top in HPL.

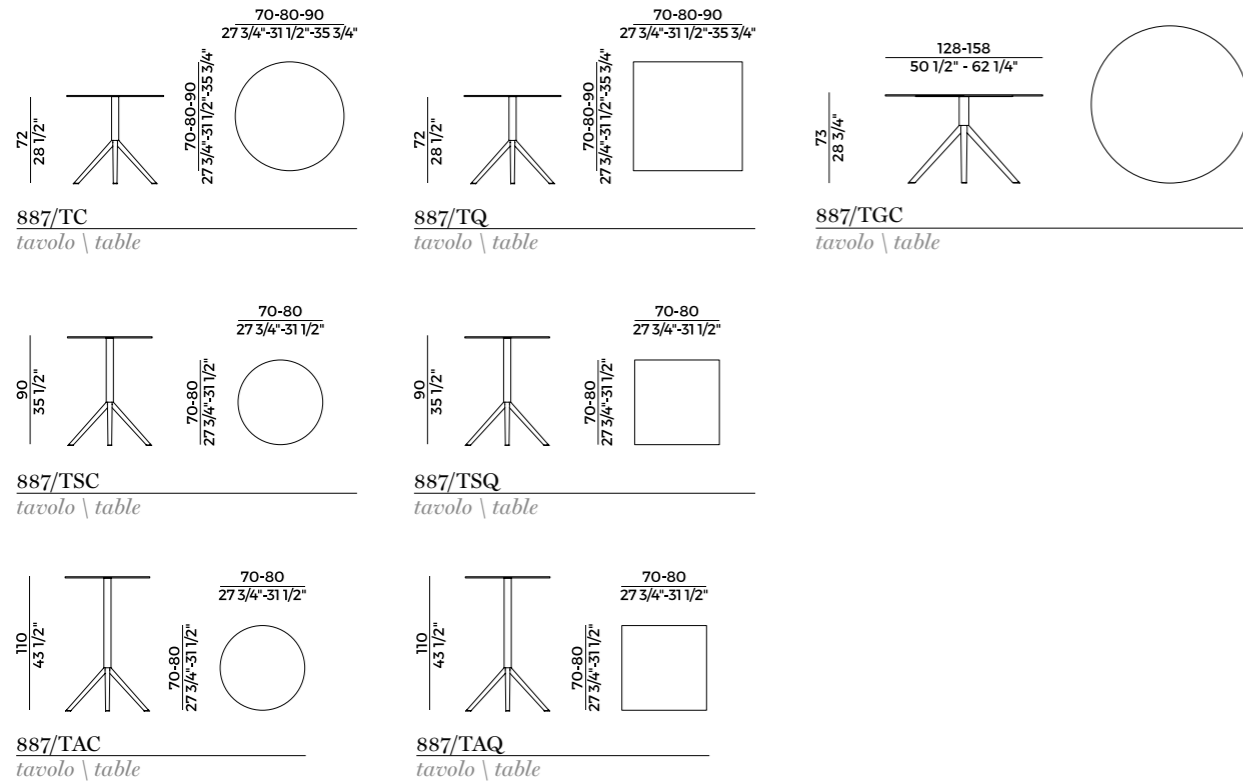

PURPLE

Design Marco Viola Studio
 \ pag. 080

Divano componibile sfoderabile, poltrona e daybed. Struttura in legno di massello di faggio e multistrato di betulla e imbottitura in poliuretano espanso ignifugo. Rivestimenti di collezione.

Modular sofa with removable covers, armchair and daybed. Frame in solid beech wood and birch plywood and padded with fire retardant polyurethane foam. Coverings as per collection.

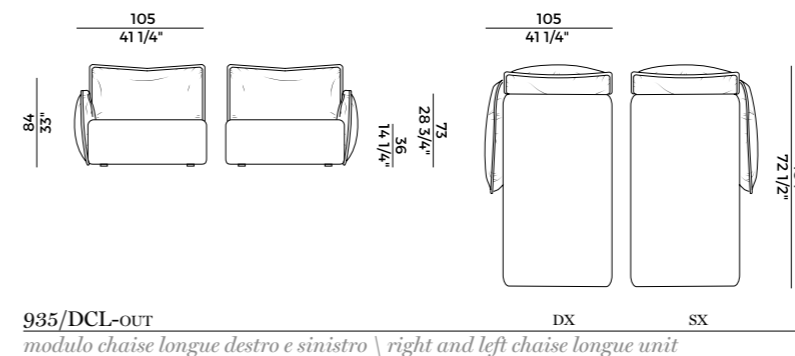
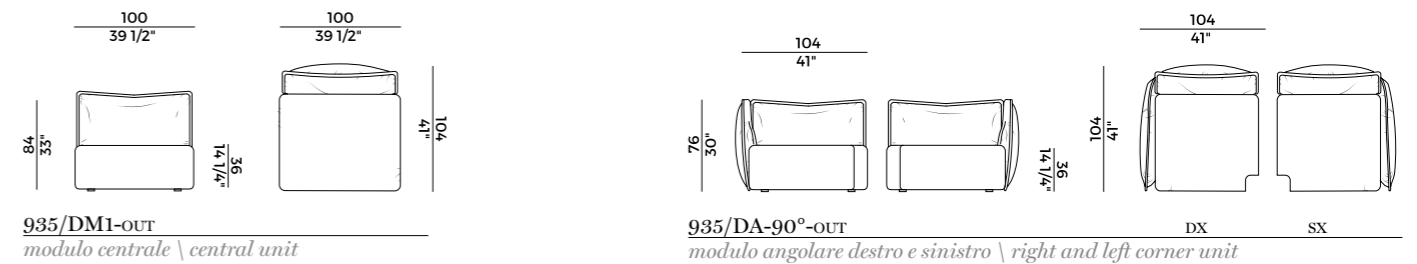
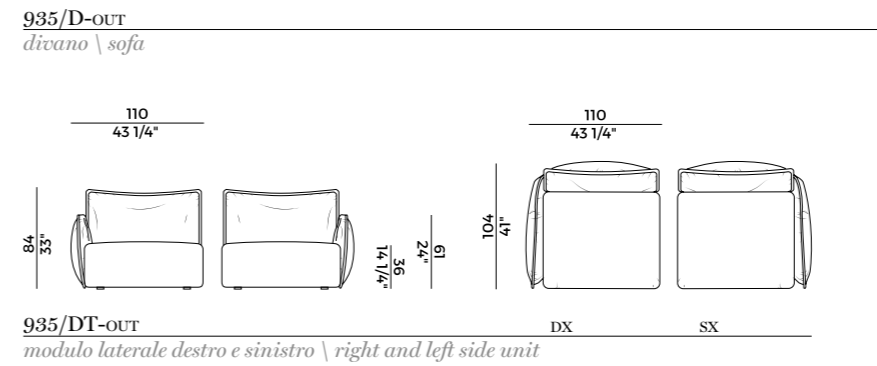
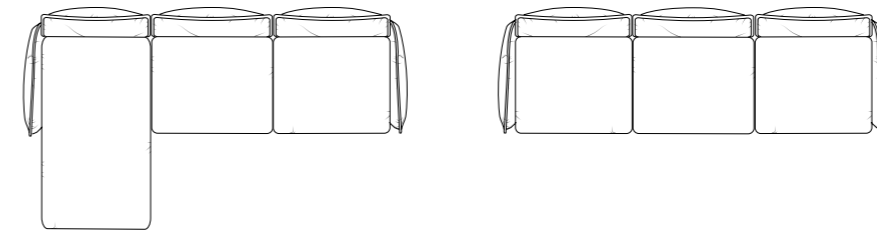
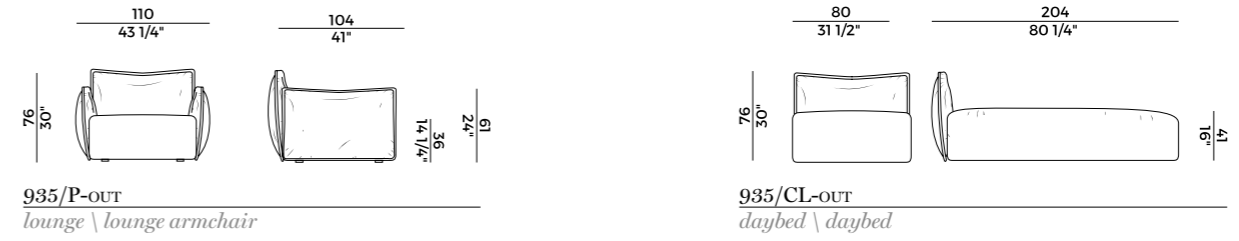

ROPU

Design Chiara Andreotti
 \ pag. 128

Collezione di tavolini e pouf, con struttura in metallo verniciato antracite goffrato. Cornice con intreccio in cordino "Gassa" testa di moro. Tavolini con top rettangolare o tondo in grès porcellanato o HPL. Pouf rettangolare con cuscino sfoderabile.

Collection of coffee tables and pouf, with anthracite embossed lacquered metal structure. Frame with weaving in dark brown "Gassa" rope. Coffee tables with rectangular or round top available in laminated porcelain or HPL. Rectangular pouf with cushion with removable coverings.

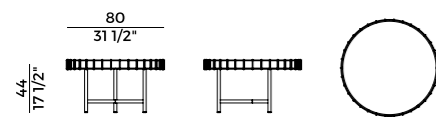

888/TBC
 tavolino \ coffee table

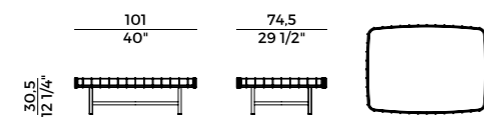

888/TBR
 tavolino \ coffee table

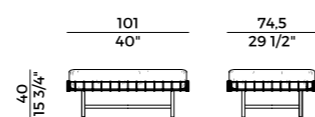

888/CQR-OUT
 pouf \ pouf

SUNO

Design Johan Lindstén
 \ pag. 146

Lettino regolabile con struttura e doghe in legno massello di Iroko e ruote in HPL antracite. Cuscino opzionale imbottito in DryFeel. Rivestimenti di collezione.

Adjustable sunbed with Iroko solid wood frame and slats, anthracite HPL wheels. Optional cushions padded in DryFeel. Coverings as per collection.

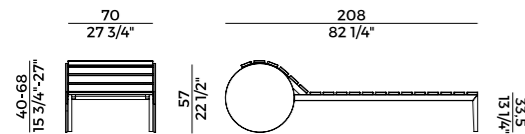

895/D-RECL
 lettino \ sunbed

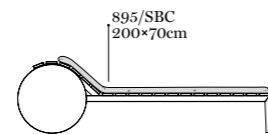

895/SBC
 cuscino \ cushion

VELA

Design Hannes Wettstein
 \ pag. 052

Sedia, poltroncina, poltrona impilabili, sgabelli e divano. Struttura in metallo verniciato antracite, bianco o Aval. Disponibile con intrecci in cordino nautico o cordino PVC. Abbinamenti predefiniti di collezione.

Stackable chair, small armchair, armchair, stools and sofa. Frame in anthracite, white or Aval lacquered metal. Available with nautical or PVC rope weaving. Default combinations as per collection.

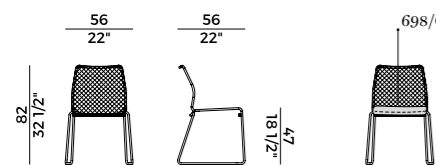

698
 sedia \ chair

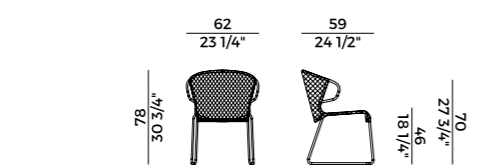

698/P
 poltrona \ armchair



698/P-C
 cuscino \ cushion

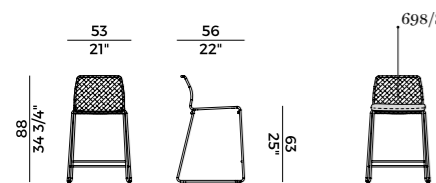

698/S
 sgabello basso \ counterstool

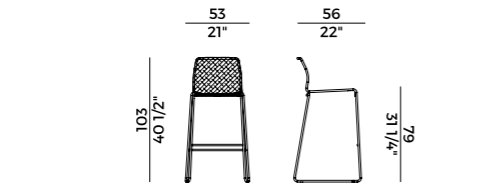

698/A
 sgabello alto \ barstool

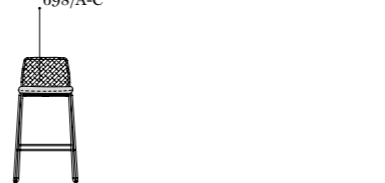

698/A-C
 cuscino \ cushion

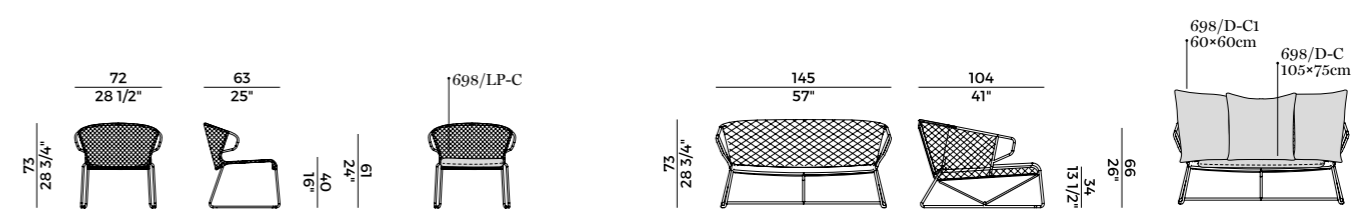

698/LP
 lounge \ lounge armchair

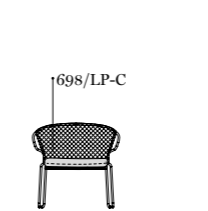

698/LP-C
 cuscino \ cushion

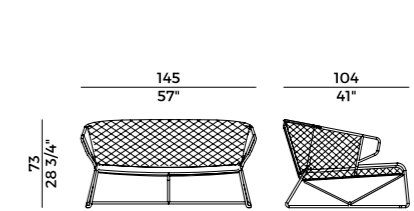

698/D
 divano \ sofa

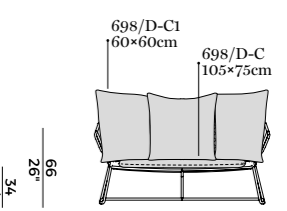

698/D-C1
 60x60cm
 698/D-C
 105x75cm
 cuscini \ cushions

VELIS

Design Mario Ferrarini
 \ pag. 048

Poltroncina con struttura in legno massello di Iroko e schienale con struttura in metallo verniciato intrecciato in cordino "Gassa" testa di moro o corda nautica canapa. Seduta imbottita in poliuretano espanso. Cuscino schienale incluso. Finiture e rivestimenti di collezione.

Armchair with Iroko solid wood frame and back with painted metal frame woven in dark brown "Gassa" rope or hemp nautical rope. Seat padded in polyurethane foam. Back cushion included. Materials and coverings as per collection.

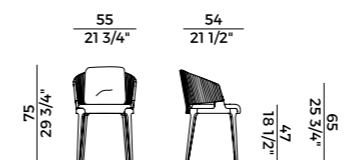

942/PAR
 poltrona pozzetto \ tub chair

WELD

Design Busetti, Garuti e Redaelli
 \ pag. 134

Collezione di tavolini con struttura in metallo verniciato in due diverse altezze. Dettaglio della base intrecciato in corda nautica canapa o cordino "Gassa". Piano in HPL o legno massello di Iroko.

Collection of coffee tables with painted metal frame in two different heights and top sizes. Base detail woven in nautical rope or "Gassa" rope. Top in HPL or Iroko solid wood.

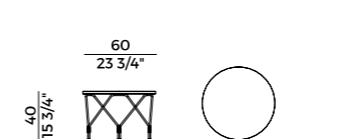

865/TCB
 tavolino \ coffee table

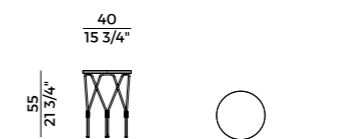

865/TCH
 tavolino \ coffee table

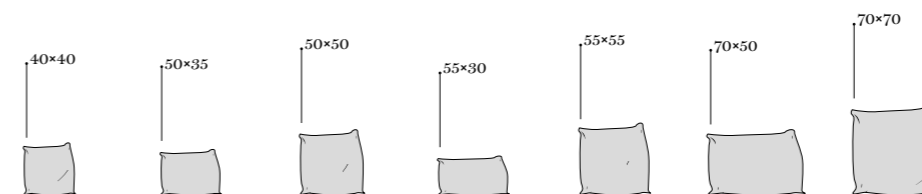

cuscini decorativi \ decorative pillows

Fin-
ishes

05.



adatto per uso interno
suitable for indoor use



adatto per uso esterno
suitable for outdoor use



adatto per uso esterno in ambiente salino
suitable for outdoor use in salty environments

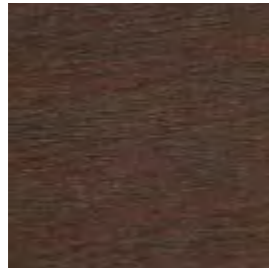

articolo ignifugo
flame retardant

Essenze | *Essences*EK
Mogano Tinto Noce \
Mahogany Walnut StainedEU
Iroko \
Iroko

Il legno è un prodotto naturale. Ogni elemento possiede un proprio colore e struttura. Gli articoli acquistati in tempi diversi potrebbero mostrare differenze di colore e lucentezza. La pulizia giornaliera può essere fatta con un panno umido. Un'occasionale e più accurata pulizia, invece può essere effettuata con un detergente specifico per il legno. Da evitare l'utilizzo di spugne e detersivi abrasivi.

Wood is a natural product. Each element has its own colour and structure. Items purchased at different times may show differences in colour and brightness. Daily cleaning can be done with a soft wet cloth. Occasional more accurate cleaning can be done with a wood-specific detergent. Avoid abrasive sponges or detergents.

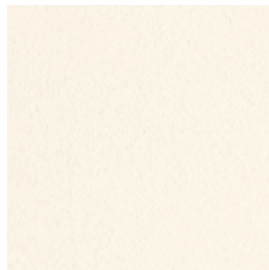
Metalli Verniciati | *Lacquered Metals*Bianco Goffrato \
White EmbossedAntracite Goffrato \
Anthracite EmbossedAval Goffrato \
Aval Embossed

La pulizia giornaliera può essere fatta con un panno umido. Una più accurata pulizia può essere effettuata con un panno inumidito in acqua fredda con sapone neutro. Da evitare l'utilizzo di spugne e detersivi abrasivi.

Daily cleaning can be done with a damp cloth. A more accurate cleaning can be carried out with a cloth dampened in cold water and neutral soap. Avoid using sponges and detergents that are abrasive.

InoxInox Lucido Aisi 316 \
Inox Aisi 316 Polish

Sciogliere saltuariamente (circa una volta/mese) con acqua dolce, in caso di sporco pulire con sapone o detersivi neutri utilizzando spugne o panni non abrasivi e, successivamente, risciacquare con acqua.

Rinse occasionally (about once a month) with fresh water. In case of dirt, clean it with soap or neutral detergents using non-abrasive sponges or cloths and then rinse with water.

Ceramica | *Ceramic*Grigio Sabbia \
Sand GrayPesca \
Peach

La pulizia giornaliera può essere fatta con un panno umido.

Daily cleaning can be done with a damp cloth.

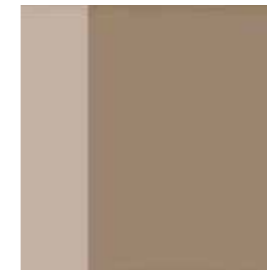
Vetro | *Glass*Float Trasparente \
Transparent FloatBronzato \
Bronzed

La pulizia dei nostri vetri è molto semplice: utilizzare un panno in microfibra, o in alternativa un panno morbido che non lasci però "pelucchi", inumidito con detergente per vetri e/o alcool. Asciugare subito dopo con un panno asciutto per non lasciare aloni. Evitare di lasciare sul piano pagliette o materiali abrasivi per evitare la formazione di graffi.

Cleaning our glass is very easy: use a microfiber cloth, or alternatively a soft cloth (that does not leave "lint") moistened with glass cleaner and/or alcohol. Dry immediately with a dry cloth to avoid leaving marks. Avoid leaving abrasive wire sponges or other materials on the glass top to prevent scratches.

Grès Porcellanato | *Laminated Porcelain*Ossido Nero \
Black Ossido

Materiale resistente ai graffi e all'usura, alle alte temperature e al gelo, al fuoco, a quasi tutti gli agenti chimici e all'azione dei raggi UV. Facile da pulire, igienico e completamente riciclabile. Pulire con un panno umido e un detergente neutro non invasivo.

This material is resistant to scratches and wear, high temperatures and frost, fire, almost all chemicals and UV rays. It's easy to clean, hygienic and fully recyclable. Wipe with a damp cloth and a non-invasive neutral detergent.

HPL | HPL  



Bianco \
White

Antracite \
Anthracite

Orchidea \
Orchid

I piani in HPL presentano una decorazione color marrone sui bordi. Il nucleo è ignifugo, la superficie resistente ai raggi UV ed estremamente resistente agli agenti atmosferici grazie alla resina a doppio indurimento (Fire Test EN 13501-1, B-s2, d0).

Pulire utilizzando una spugna morbida non abrasiva o una spazzola morbida (es. con setole di nylon); utilizzare un detergente non abrasivo.

HPL tops are characterized by brown edges. The core is flame-retardant and the surface is lightfast. Thanks to the double-hardened resin, it is also extremely weather resistant. (Fire Test EN 13501-1, B-s2,d0).

Clean using a soft non-abrasive sponge or a soft brush (eg with nylon bristles); use a non-abrasive detergent.

Cordini | Ropes  



K1
Sintetico Moka \
Moka Syntetic
Ø 4 mm

Cordini PVC | PVC Ropes   



J7
PVC Bianco Opaco \
White Matt PVC
Ø 4 mm

G2
PVC Antracite Opaco \
Anthracite Matt PVC
Ø 4 mm

G1
PVC Havana Opaco \
Havana Matt PVC
Ø 4 mm

Usare acqua dolce, tiepida, qualsiasi altro detergente potrebbe rovinare la superficie.

The use of fresh or warm water, and of any other detergent may damage the surface.

Cordini Gassa | Gassa Ropes   



B1A
Gassa Beige \
Gassa Beige
Ø 6 mm

F7E
Gassa Testa di Moro \
Gassa Dark Brown
Ø 4 mm

F8F
Gassa Testa di Moro \
Gassa Dark Brown
Ø 6 mm

Fettucce Fly | Fly Ribbons   



S4E
Grigio \
Gray
Ø 8 mm

Fettucce Nautiche | Nautical Ribbons   



F9
Canapa \
Hemp
Ø 10 mm

D4
Antracite \
Anthracite
Ø 10 mm

D5
Blue Navy \
Blue Navy
Ø 10 mm

Corde Nautiche | Nautical Ropes   



F9B
Canapa \
Hemp
Ø 4 mm

D4B
Antracite \
Anthracite
Ø 4 mm

D5B
Blue Navy \
Blue Navy
Ø 4 mm

Usare acqua dolce, tiepida, qualsiasi altro detergente potrebbe rovinare la superficie.

The use of fresh or warm water, and any other detergent may damage the surface.

Sea | Cat. 1



100% solution dyed outdoor acrylic fibre \ Martindale 17.000 cicli/rubs



H1C Tortora H1E Bianco H1D Beige Chiaro H1A Mattone H1G Bordeaux H1B Marrone Scuro

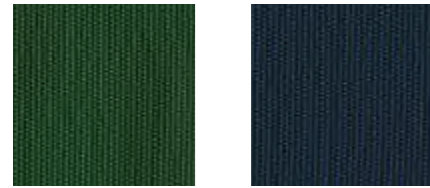

H1F Verde Oliva H1H Blu Notte

Sun | Cat. 1



100% solution dyed outdoor acrylic fibre \ Martindale 17.000 cicli/rubs

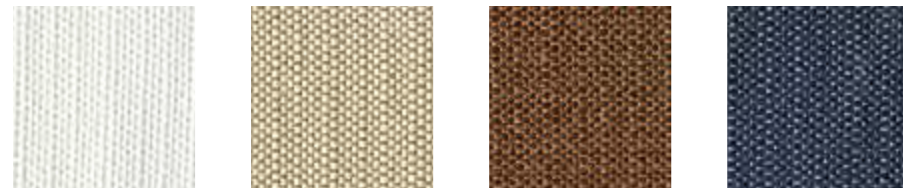

D1E Bianco D1A Beige D1B Marrone D1D Blu

Sky | Cat. 2



100% Polipropilene | Polypropylene \ Martindale >25.000 cicli/rubs



T2A Unito Beige T2B Drill Beige T2C P. D. P. Beige T2D Unito Verde T2E Drill Verde T2F P.D.P. Verde



T2G Unito Grigio T2H Drill Grigio T2I P.D.P. Grigio T2J Unito Blu T2K Drill Blu T2L P. D. P. Blu

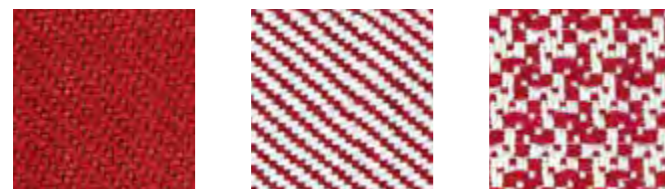

T2M Unito Rosso T2N Drill Rosso T2P P. D. P. Rosso

Sail | Cat. 3



100% solution dyed outdoor acrylic fibre \ Martindale 26.000 cicli/rubs



R1B Marrone R1A Nocciola R1C Nero

Soul | Cat. 4



100% Polyolefinic FR \ Martindale >50.000 cicli/rubs \ * Flammability: BS EN 1021.1 | TB 117 | NFPA 260

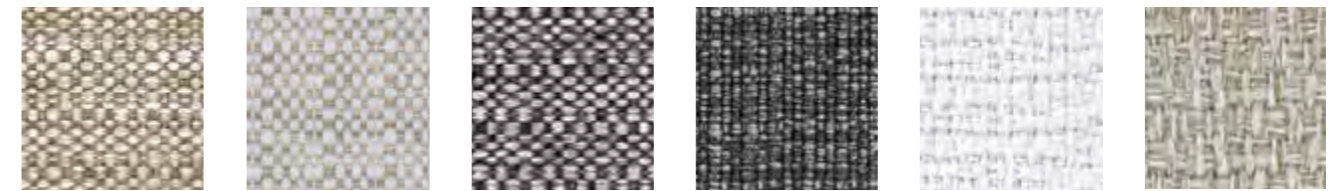

ZT Nocciola* ZU Panna* ZV Grigio* ZW Nero* ZX Bianco* ZY Beige*



ZK Arancio T1M Nero Melange T1N Blu T1P Grigio Melange T1Q Blu Melange

Sunset | Cat. 4



100% solution dyed outdoor acrylic fibre \ Martindale 40.000cicli/rubs \ Flammability: BS 5852 | TB 117 | NFPA 260

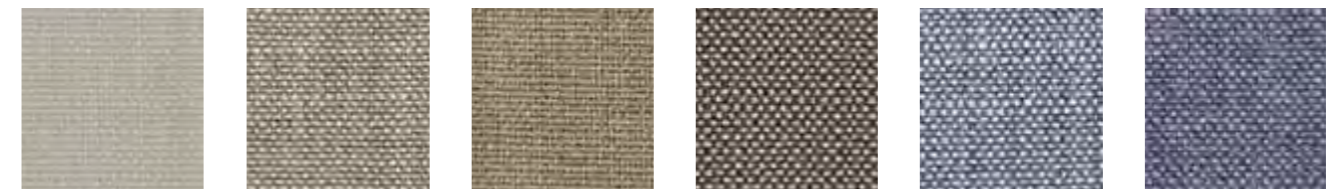

T1A Panna T1B Beige Chiaro T1C Beige T1D Tronco T1E Light Blu T1F Blu



T1G Grigio T1H Grigio Chiaro T1I Nocciola T1J Grigio Scuro T1K Antracite T1L Cielo

Sono idro e oleo-repellenti, immuni alla formazione di funghi e muffe, resistenti alle macchie, alla salsedine e allo sbiadimento dovuto all'azione dei raggi UV. Si consiglia il lavaggio professionale.

They are hydro and oleo-repellent, immune to the formation of fungus and molds, resistant to stains, saltiness and fading due to the action of UV rays. Professional washing is recommended.

POTOCO
ITALY

© 2019 Potocco Spa
Via Indipendenza 4
33044 | Manzano | Udine | Italy
T. +39 0432 745111
info@potocco.it

Potocco Asia Pacific Division
Singapore 207847
potoccoasia@potocco.it

Potocco USA
Hickory, NC 28602
United States of America
customerservice@potocco-usa.com

Potocco reserves the right to introduce any changes to its own models without prior notice. Color tones may vary from one dye lot to another.

© 2019 by Potocco Spa
All rights reserved



The mark of
responsible forestry
*Richiedi i nostri
prodotti certificati
FSC®*



www.potocco.it



Project and Art Direction
R+W

Project Coordination
Potocco Corporate Image Team

Photos
Miro Zagnoli

Other photographs
Filippo Savoia \ p. 002-003
Officine Fotografiche Friulane \ p. 005
Matteo Baldan \ p. 014-015

Styling
Ilaria Bacciocchi

Printed in Italy
Poligrafiche San Marco
September 2019

Thanks to
MMairo – Marble & Design
Bloc studios
cc-tapis
Astep
Oluce
Warli Tappeti contemporanei
Society Limonta
Salvatori
Normann Copenhagen